

Concrete and Clay Roof Tile Installation Manual

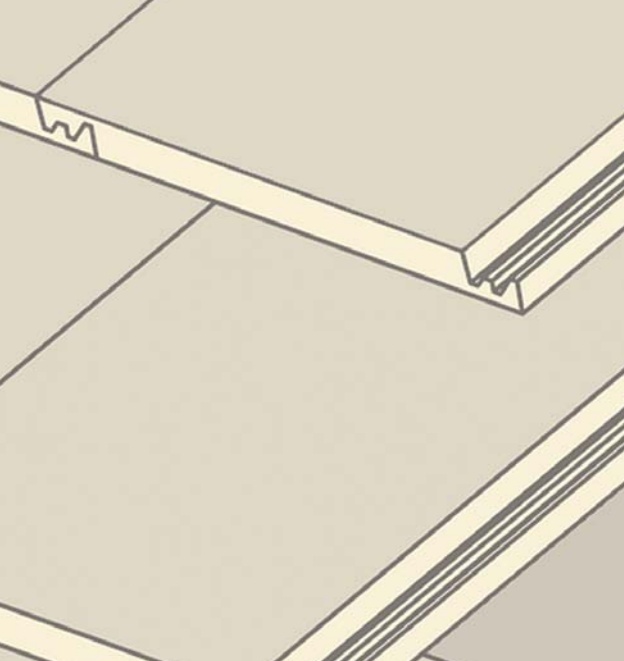

Imagine the Possibilities
Realize the Benefits



Published by
Tile Roofing Institute & Western States Roofing Contractors Association

FOREWORD

The Tile Roofing Institute (TRI) is the premier resource for technical information on the proper design and installation of concrete and clay roof tile systems. The Tile Roofing Institute in partnership with the Western States Roofing Contractors Association (WSRCA) assembled a task group in 1991 to develop an installation manual that would provide a representation of proper installation practices, industry standards, and code requirements. These recommendations have provided successful installations of roof tile which have endured the test of time.

The TRI and WSRCA technical committees along with valuable input from the entire roofing community reviewed the previous 2010 edition of this manual. The culmination of those efforts was the creation of this 2015 Edition of the Installation Manual. As with all previous editions, the TRI submitted the manual for formal review and issuance of a valid Evaluation Report from an approved evaluation report source. The TRI and WSRCA submitted this manual for formal review and issuance of an IAPMO Uniform ES Evaluation Report, ER-2015, to help provide a stronger foundation to the formal practices and recommendations included in this manual.

The Tile Roofing Institute offers additional installation manuals Concrete and Clay Tile Roof Design Criteria Manual for Cold and Snow Regions and 5th Edition FRSA/TRI Concrete and Clay Roof Tile Installation Manual. All of our publications can be ordered through the publication page on our website (www.tilerroofing.org). The TRI will be offering formal installer training programs based upon the manuals to allow roofing professionals to become certified tile installers.

TRI continues to provide the leading edge technology for roof innovations that will provide the highest quality, energy efficient roofing systems available in the market today. Tile roofing systems provide one of the most durable, energy efficient roofing systems found anywhere in the world.

Updates and Bulletins - The Tile Roofing Institute would like to make sure that we provide the latest information and updates available directly to you. If you would like to receive notices of any changes, updates, or provide comments on this manual please visit our website www.tilerroofing.org or email us at info@tilerroofing.org and ask to be placed on our email listing for future notices.

LIMITATIONS ON USE AND DISCLAIMER FOR THIS TRI/WSRCA INSTALLATION MANUAL

These drawings and recommendations are the compilation of the individual experiences of industry members and the Technical Committee of the TRI/WSRCA. It is intended to be used with the judgment and experience of professional personnel competent to evaluate the significance and limitations of the material contained and who will accept responsibility for its application. The TRI/WSRCA expressly disclaims any guarantees or warranties, expressed or implied, for anything described or illustrated herein; and assumes no responsibility for error or omissions.

PRINTED IN THE U.S.A.

TABLE OF CONTENTS

Introduction	1
Tools Required	1
Safety Warning - Tile Dust/Governing Bodies/Environmental Statement	2
Specifications	3 - 6
Suggested Material Checklist/Roof Tile Classifications	3
Tile Specifications/Materials and Manufacture	4 - 6
Installation	7 - 14
General Information	7
New Construction	8 - 9
Reroofing	9
Ventilation Guidelines	9
Table 1A Roof Tile Application	10
Table 1B Roof Tile Application	11
Table 2 Batten Allowable Loads	12
Table 3 Guidelines for Battens	13
Table 4 Roof Slope Conversion	14
Table 5 Metric Conversion	14
Appendix A - Installation Detail Drawings	15 - 74
Identification of Roof Areas	15
Single-Layer Underlayment	16
Double Layer Underlayment	17
Tile Penetration Flashing	18
Valley Underlayments (Woven Underlayment)	19
Valley Underlayments (Overlapping Underlayment)	20
Batten Layout Options	21
Counterbatten Installation	22
Vertical Battens - For Deep Trough Valley	23
Vertical Battens - For Standard Valley and Hips	24
Establishing Vertical Alignment	25
Roof Layout	26
Roof Layout - Quick Reference	27
Suggested Loading Guide	28
Down Slope Eave Details	29
Raised Fascia	30
Eave At Flush Wall or Fascia/Zero Overhang	31
Low Slope/Ventilated Roof Eave Detail	32
Double Lap Tile (Non-Interlocking)	33
Head Wall Metal Flashing (With Counterflashing)	34
Head Wall Metal Flashing (Without Counterflashing)	35
Pan Flashing At Roof-To-Sidewall (Where Wall Extends Past Eave With Counterflashing)	36
Pan Flashing At Roof-To-Sidewall (Where Wall Extends Past Eave)	37
Metal Flashing Options	38
Sidewall Details - Clay 'S' Tile	39
Sidewall Details - Two Piece Clay	40
Chimney Flashing - Pan Type	41
Chimney Flashing - Step Type	42
Chimney Cricket Flashing - Pan Type	43

Chimney Cricket Flashing - Step Type	44
Skylight Underlayment Detail	45
Skylight Flashing - Pan Type	46
Skylight Step Flashing	47
Open Valley - Tile Installed With Gap At Valley Metal	48
Three Rib Valley Metal Profiles	49
Valley Metal - For Deep Trough Valley	50
Valley Transitions	51
Boxed-in Soffit	52
Hip And Ridge A	53
Hip And Ridge B	54
Vented Ridge (Option)	55
Parapet Or Mansard Condition	56
Rake Flashing - Counter Batten System	57
Rake Flashing - Options	58
Rake Tile Installation	59
Gable / Eave Installation - Barrel Tile	60
Gable / Eave Installation	61
Roof Vents (Off Ridge)	62
Slope Change Applications	63
Gutters	64
Tile Repairs / Replacement	65
Tile Repairs / Replacement - Continued	66
Specialty Conditions- Pre-Engineered Roof (Installation on Metal Deck - Considerations)	67
Specialty Conditions- Pre-Engineered Roof (Installation on Metal Deck - Optional Considerations)	68
Specialty Conditions- Pre-Engineered Roof (Installation on Metal Deck - Optional Considerations)	69
Specialty Conditions- Pre-Engineered Roof (Installation on Metal Deck - Optional Considerations)	70
Specialty Conditions- Pre-Engineered Deck (Installation on Concrete Deck Considerations)	71
Specialty Conditions- Pre-Engineered Deck (Installation on Concrete Deck Considerations)	72
Specialty Conditions- Pre-Engineered Roof (Wire Attachment System)	73
Specialty Conditions- Pre-Engineered Roof (Wire Attachment System)	74
Specialty Conditions- Nailer Installations	75
Appendix B - Specialty Installations	76
Draped Underlayment Applications	76
Installation of Underlayments Under Spaced Sheathing	76
Adhesive Fastening Systems	77
Design Considerations for High Wind Applications Under IBC and IRC (ASCE-7-05)	77 - 86
Design Considerations for High Wind Applications Table 5A (ASCE 7-05)	79
Design Considerations for High Wind Applications Tables 5B & 5C (ASCE 7-05)	80
Design Considerations for High Wind Applications Tables 5D & 6A (ASCE 7-05)	81
Design Considerations for High Wind Applications Table 6B & 6C (ASCE 7-05)	82
Design Considerations for High Wind Applications Table 6D, 6E, & 6F (ASCE 7-05)	83
Allowable Aerodynamic Uplift Moments Mechanical Fastening Systems Table 7A	84
Allowable Aerodynamic Uplift Moments Mechanical Fastening Systems Table 7A cont'd	85
Allowable Aerodynamic Uplift Moments Mechanical Fastening Systems Notes	86
Design Considerations for Installations in Earthquake Regions	86
Appendix C - Applications Under 2012 IBC and IRC (ASCE 7-10)	87 - 96
Design Considerations for High Wind Applications Under 2012 IBC and IRC (ASCE 7-10)	87

Design Considerations for High Wind Applications Table 8 (ASCE 7-10)87
Application Examples 1– 590-92
Design Considerations for High Wind Applications Table 9A (ASCE 7-10) 90
Design Considerations for High Wind Applications Table 9B (ASCE 7-10) 91
Design Considerations for High Wind Applications Table 9C (ASCE 7-10) 92
Design Considerations for High Wind Applications Table 9D (ASCE 7-10) 93
Design Considerations for High Wind Applications Tables 10A (ASCE 7-10) & 10B (ASCE 7-10) 94
Mechanical Roof Tile Resistance Values Table 11 (ASCE 7-10) 95
Adhesive Fastening Systems/Mortar Fastening Systems Outside the Scope of this Manual 96
Appendix D - Glossary of Terms97 - 99

INTRODUCTION

These recommendations are meant for areas that may experience occasional storms, but not regular repetitive freeze thaw cycling. In locations where the January mean temperature is 25 deg. F (-4 deg C) or less or where ice damming often occurs, the TRI /WSRCA suggests reference to the Concrete and Clay Tile Roof Design Criteria Manual for Cold and Snow Regions. While generally considered the minimum standard, proper adherence to these recommendations and attention to detail and workmanship provide a functional roof in most all moderate climate conditions. Local building officials should be consulted for engineering criteria or other special requirements.

The manner in which tile roofs are installed makes them a highly effective water shedding assembly that affords years of service and protection. The effectiveness of a tile roof system as a weather resistant assembly however depends on the proper installation of all the tile roof components, and installing them properly is critical to the performance of the installed system.

Since tile is installed across a wide range of climatic and geographic conditions, there are a variety of details that must be considered in preparing an effective installation. The minimum recommendations shown for moderate regions are effective for a relatively wide range of conditions including occasional storms or snow. While it is not practical to prescribe precise solutions for all conditions, the following has been provided to offer suggestions for various treatments in a most climatic climate application. Local building officials should always be consulted to learn of special requirements that may exist. Some of the changes contained will require code approval.

This manual provides the minimum design recommendations with optional upgrades for the installation of underlayment, flashings, fastening and related measures to provide a weather resistant roofing assembly for concrete and clay tile.

Designers should be familiar with local climatic conditions and make sure that they are reviewing the proper design manual. Please see the following list of reference publications for additional information.

TOOLS REQUIRED (Other items may be required per field conditions)

Basic Hand Tools			Power Tools		
Tape Measure	Crayon	Hammer	Drill	3/16" Masonry Bit	Screw Gun
Tin Snips	Felt Knife	Nail Bag	Power Cords	Compressor w/ Hose	Nail Gun
Chalkline	Chalk	Pry Bar	Tile Saw	Diamond Saw Blade	
Metal Crimper	Mortar Trowel	Mastic trowel			
Caulking Gun	Hand Saw	Roller			
Brush	Broom				
Specialty Tools & Equipment			Safety & Personal Protective Equipment Per Federal & State OSHA Requirements		
Forklift	Conveyor	Tile Cutter			
Ladder	Tile Nippers				

SAFETY WARNING - TILE DUST

Roofing tiles contain crystalline silica (quartz) and traces of other hazardous substances which are released as dust and can be inhaled when dry-cutting or grinding this product.

WARNING: Crystalline silica is a substance known to cause cancer. Other chemicals contained in these products are known to cause cancer, birth defects and other reproductive harm. Please refer to Federal and State OSHA requirements for proper compliance.

REFERENCE PUBLICATIONS

Standard Installation Guides for Concrete and Clay Roof Tile in Cold Weather Applications. Published 1998 by the NTRMA/WSRCA

Concrete and Clay Roof Tile Installation Manual Fifth Edition (For Florida only) Published April 2012 (04-12) by the FRSA/TRI

CAN/CSA-A220.1-M91 – Installation of Concrete Roof Tiles, by the Canadian Standards Association

The European Standards Association, Australian Standards Association, Japanese Standards Association

TERMINOLOGY

Please see Appendix D for a listing of terms associated with roof tile.

GOVERNING CODE BODIES

Information contained herein is based on values and practices consistent with provisions of the major building codes such as the International Building Code (IBC), International Residential Code (IRC), as promulgated by the

International Code Council (ICC). For evaluation reports for concrete and clay roof tiles that specifically reference this manual, installation shall be in accordance with this manual and the applicable code, unless otherwise noted in the roof tile evaluation report.

ENVIRONMENTAL STATEMENT

The members of the TRI/WSRCA are environmentally conscious companies whose policies and practices reflect a commitment to the preservation and welfare of our environment. Our roofing tiles are manufactured in accordance with all prevailing environmental guidelines

and are composed of sand, cement, natural clay materials and natural pigments. Because roofing tiles are designed to last long term, they will not add to the tremendous volume of other roofing materials that burden our landfills.

MATERIAL CHECKLIST(Other options/upgrades may be allowed per codes)

<p>Decking: Sheathing must be adequate to support the loads involved, but not less than nominal 1-inch-thick lumber or nominal 1⁵/₃₂-inch-thick plywood or other decking material recognized in a code evaluation report or by the local building official.</p> <p>Underlayment: ASTM D226 Type II (No. 30 felt) /ASTM D4869 Type IV or ASTM D 1970 (self adhering), meeting AC 152.</p> <p>Battens: Nominal 1" x 2" complying with IBC Chapter 23, section 2302 (nominal size).</p> <p>Eave Treatments: Bird Stop/Eave riser.</p> <p>Valley Flashing: Shall extend each way 11" from center and have a splash diverter rib 1" high. See Table A on page 4 for more details.</p> <p>Wall Trays (Pans): Minimum 6" trough. See Table A on page 4 for more details.</p>	<p>Roof To Wall: Minimum 3" coverage over tile or flexible flashing. See Table A on page 4 for more details.</p> <p>Pipe Flashing: Deck & Tile flashing is required. Profile tile flashing to be malleable metal flashings. See Table A on page 4 for more details.</p> <p>In wall Counter Flashing: Z bar recommended or surface mount reglet (pin) Flashing for re-roof. See Table A for more details.</p> <p>Fasteners: See page 6 and Table IA/IB for requirements.</p> <p>Ventilation: Per local building code requirements.</p>
---	--

ROOF TILE CLASSIFICATIONS

Roof tiles manufactured are typically of the following types:

Low Profile Tile – Tiles, such as flat tile that have a top surface rise of 1/2" or less.

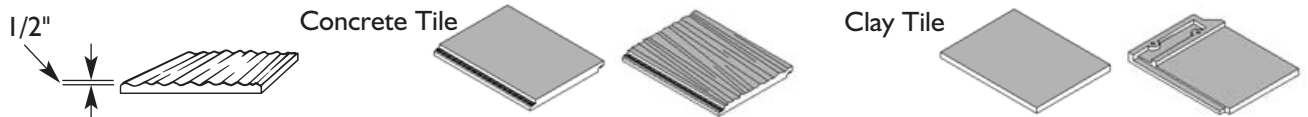

Medium Profile Tile – Tiles having a rise to width ratio equal to or less than 1:5

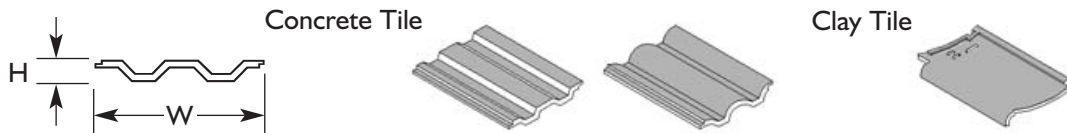

High Profile Tile – Tiles having a rise to width ratio greater than 1:5 (measured in installed condition)

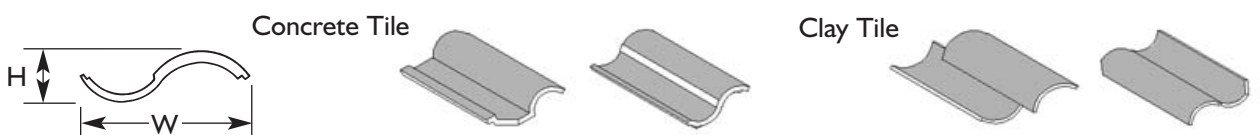

Accessory Tile – Shall include those tile such as ridge, rake, hip, valley and starter tile used in conjunction with those tile listed above.

TABLE A**REFERENCE TABLE FOR DRAWING DETAILS**

TYPE	SPECIFICATIONS	DETAILS
VALLEY FLASHING	NO. 26 GALVANIZED SHEET GAUGE NOT LESS THAN 0.019" ASTM A653 G90	MC-12B, MC-17, MC-17A, MC-17B
PAN FLASHING CHANNEL FLASHING WALL TRAYS FLASHING		MC-12, MC-12A, MC-12B, MC-13, MC-13A
HEADWALL FLASHING ROOF TO WALL FLASHING APRON FLASHING		MC-11, MC-11A
COUNTER FLASHING Z BAR FLASHING		MC-11, MC-12, MC-13, MC-13A
DRIP EDGE FLASHING EAVE FLASHING		MC-10, MC-10A, MC-10B, MC-10C, MC-10D
RAKE FLASHING		MC-12B, MC-19, MC-19A
CHIMNEY FLASHING SKYLIGHT FLASHING SADDLE FLASHING		MC-14, MC-14A, MC-15, MC-15A, MC-16A, MC-16B
PIPE FLASHING DECK FLASHING		MC-02, MC-21
ROOF VENTS ATTIC VENTS		MC-21
PROFILE TILE FLASHING		SOFT LEAD NOT LESS THAN 3 LBS / SQ.FT DEAD SOFT ALUMINUM NOT LESS THAN 0.019" SOFT COPPER NOT LESS THAN 16 OZ/SQ.FT
ACCESSORIES		
TYPE	SPECIFICATIONS	DETAILS
BIRDSTOP EAVE RISER WEATHER BLOCKING	PER MANUFACTURER	MC-10A, MC-10B, MC-10C, MC-23, MC-25 PER MANUFACTURER'S SPECIFICATIONS MC-18, MC-18A, MC-18B

* All flashings above are considered minimums.

* For other special metal type upgrades see IBC Tables 1507.4.3(1) and 1507.4.3(2) or IRC Tables R905.10.3(1) and R905.10.3(2), as applicable.

TILE SPECIFICATIONS/ RECOMMENDATIONS

Freeze Thaw – Different climatic conditions will result in the need for different roofing materials that will allow the success of the roofing system over the long-term. Resistance to freeze/thaw is very important in weathering situations where the roofing material is expected to withstand repetitive freezing and thawing cycles. Both Concrete and Clay Tile must have passed the requirements of ASTM C1492 (Concrete) ASTM C1167 (Clay) for freeze thaw regions.

Strength – A Concrete (ASTM C1492) or Clay tile's (ASTM C1167) transverse strength will meet or exceed requirements of the specified codes.

Thickness – Roof tile typically ranges in thickness from $\frac{3}{8}$ " to $1\frac{1}{2}$ ", depending upon composition, type and style.

Quantities of Tile Per Square – The size of the tile and the exposure of each course of tile determines the number of tile needed to cover one square (100 sq. ft.) of roof area. When the tile is installed at the manufacturer's maximum exposure, the number of tile needed to cover one square of roof area may range from 75 to over 400 pieces.

Tile Weight – The size of the tile and the exposure of each course will determine the installed weight of the roof tile. In general, the amount of tile to cover one square (100 sq ft.) set at the standard 3 inch head lap, will depend on the thickness, length, width, shape and aggregate materials used in the manufacturing process of the tile. Please consult with the tile manufacturer when determining the weight of the specific tile that will be used. As with any roofing material the designer should always consider the weight of the underlayment, fastening system, roof accessories and special hip/ridge treatments.

MATERIALS AND MANUFACTURE

Concrete Tile – Cementitious materials such as portland cement, blended hydraulic cements and fly ash, sand, raw or calcined natural pozzolans and aggregates shall conform to the following applicable ASTM specifications.

Concrete Tile ASTM C1492 Specifications –

Portland Cement – Specification C150 or Performance Specification C1157
Modified Portland Cement – Specification C90
Blended Cement – Specification C595
Pozzolans – Specification C618
Ground Granulated Blast Furnace Slag – Specification C989

Aggregates such as normal weight and lightweight shall conform to the following ASTM specifications; except that grading requirements do not apply.
Normal Weight Aggregates – Specification C33
Lightweight Aggregates – Specification C331

Clay Tile – Tiles are manufactured from clay, shale, or other similar naturally occurring earthly substances and subjected to heat treatment at elevated temperatures (firing). The heat treatment must develop a fired bond between the particulate constituents to provide the strength and durability requirements.

Clay Tile ASTM C1167 Specifications –

Terminology for structural clay products – C43
Test methods and sampling and testing brick and structural clay – C67
Test methods for tensile strength of flat sandwich construction in flat wise plane – C297
Test method for crazing resistance of fired glazed ceramic whitewares by thermal shock method – C 554

Additional Standards for Concrete & Clay Tile may be referenced in the following additional standards:

IBC/IRC	ASCE 7-05
ASCE 7-10	ICC-ES AC 152
ICC-ES AC180	CAN/CSA – A220.1-M91

Adhesive – Bonding materials designed to stick tiles to tiles, or tiles to a substrate and can include mortar, synthetic mortar, mastics, silicones, polymers, Trig-polymers, or other materials approved by the local building official. Contact the adhesive manufacturer for additional information. Refer to current evaluation reports of roof tile adhesives for installation requirements and conditions of use.

Batten – A sawed strip of wood installed horizontally and parallel to the eave line which is mechanically attached to

the roof deck or rafters to engage the anchor lugs to prevent slippage of the roof tile. Battens of nominal 1"x2" lumber complying with IBC Chapter 23, section 2302 may be dimensionally increased in size to accommodate structural loads for snow or unsupported spans over counter battens or rafters. Battens may also be corrosion resistant metal, or other man-made material that meets the approval of the local building official. In dry/low humidity climates moisture resistant battens are not required. See Tables IA and IB on pages 10 and 11.

Battens installed over counter battens or which span over rafters commonly are of soft wood, spruce, pine, or fir type species but may be of any type of lumber, metal or man-made materials that meet the approval of the local building official. See table 2 on page 12.

Counter Battens – Additional set of battens installed vertically and parallel to the roof slope and mechanically attached to the roof deck under the batten. Counter battens are commonly 1/4 inch lath but may be dimensionally increased in size to provide a greater flow of air or moisture beneath the horizontal battens. Counter battens do not need to be of moisture resistant lumber as they do not impede moisture flow. Counter battens may also be of corrosion resistant metal or other man-made materials that meet the approval of the local building official. See table 2 on page 12.

Note: If counter battens are installed under the underlayment, caution must be used to prevent damage to underlayment or reinforced underlayment shall be used.

Note: Care should be taken in selecting the proper batten design. Excessive deflection of the batten may lead to tile breakage. See table 2 on page 12.

Caulking and Sealant

Caulking and sealants shall be suitable for exterior use and be resistant to weathering. The caulking and sealants shall be compatible with and adhere to the materials to which they are applied.

Nails and Fastening Devices

Corrosion resistant meeting ASTM A641 Class I or approved corrosion resistance, of No. 11 gauge diameter and of sufficient length to properly penetrate $\frac{3}{4}$ " into or through the thickness of the deck or batten, whichever is less.

The head of the nail used for tile fastening shall not be less than $\frac{5}{16}$ " (.3125") and complying with ASTM F 1667 for dimensional tolerances (+0%, -10%).

Nail Length –

Nailing of Batten

Nails for fastening battens shall have sufficient length to penetrate at least $\frac{3}{4}$ " into the roof frame or sheathing.

Nailing Tile to Batten and Direct Deck Systems

Nails for fastening roof tiles shall penetrate at least $\frac{3}{4}$ " into the batten or through the thickness of the deck, whichever is less. Once the batten is installed it becomes part of the deck for fastening purposes.

Nailing Tile to Battens on Counter Batten or Draped Underlayment Systems

Nails for fastening roof tiles shall penetrate at least $\frac{3}{4}$ " but should not penetrate the underlayment.

Nailing Accessories

Where nail(s) are required for fastening accessories, such nails shall have sufficient length to penetrate at least $\frac{3}{4}$ " into the supporting member.

Screws – Corrosion resistant meeting code approval equal of sufficient length to properly penetrate $\frac{3}{4}$ " into or through the thickness of the deck or batten, whichever is less. Screw diameter and head size should be selected to meet good roofing practices and the screw manufacturer's recommendations. See above section on nail length for additional requirements.

Staples for Battens – No 16 gauge by $\frac{7}{16}$ inch-crown by minimum 1 1/2 inch long corrosion-resistant staples.

Flashing – Flashing shall be installed at wall and roof intersections, wherever there is a change in roof slope or direction and around roof openings. Where flashing is of metal, it shall be of;

0.019" Galvanized (G90)	0.019" Aluminum
16 Oz Copper	3 lb Soft Lead.

Underlayment Materials

Single layer underlayments shall meet the minimum requirements of ASTM D226 Type II (No. 30 Felt) (ASTM D4869 Type IV), or approved equal.

GENERAL INFORMATION

Algae/Moss – In certain climatic regions of the country, the development of algae and/or moss can occur on any building material. Unlike other roofing materials, the formation of these items can easily be treated and does not deteriorate the roofing tile. The growth of moss and algae form on the dirt and moisture on the surface of the tile.

Algae – Like the moss, the algae can be easily removed through the use of pressure washers. Often times a very dilute amount of bleach can help kill the algae and slow down the re-occurrence. Again, this should be left to the professionals to perform.

Moss – In most cases the use of a high pressure cleaner will remove the presence of the moss that traditionally grows in the dirt/pine needles or other debris that accumulates on the edge of the tile. Note that you may wish to contact a professional to clean your roof, since roofs can be extremely dangerous to walk on.

Shading – Slight variations in sand, cement, and color oxides (natural products) can cause minimal color shading. This slight variance is not detectable through standard quality control practices. In order to minimize color patterning, stair stepping, or hot-spots, tile should be selected and spread over the entire roof plane when loading the tile on the roof.

Broken Tile Replacement – The broken tile is first removed, if battens were used originally, existing fasteners if any, are cut, removed, underlayment repaired and the new tile is inserted. If no battens were used, a 12" x 6" by ½" plywood piece is nailed to the deck to act as a batten. As an alternative, new tiles may be inserted using roofers mastic, hooks, wires or approved adhesives to form the bond at the head of the lap area. See pages 65 and 66 (Tile Repair).

Efflorescence – Efflorescence is a temporary surface discoloration common to all concrete based roofing tile. It is a nuisance not only to the manufacturer, but also those involved in specification, installation, and usage. It is however, in no way detrimental to the overall quality, structural integrity, or functionality of the tile.

Efflorescence is mostly caused by the chemical nature of the cement. Manufactured cement contains free lime, and when water is added, a series of chemical reactions take place. These reactions are accompanied by the release of calcium hydroxide which can form a white chalky crystalline salt deposit on the tile surface when reacting with carbon dioxide. This reaction can appear as an overall "bloom" (overall softening of color) or in more concentrated patches.

It is difficult to predict how long the effects of efflorescence will last. It depends on the type and amount of deposit as well as the local weather conditions. The action of carbon dioxide and rain water will gradually, in most cases, remove the deposit leaving the original color of the concrete roof tile intact without further efflorescence.

Walkability – The inert nature of tile, its characteristics of strength over age, and its durability will contribute to a long term life expectancy. With a good installation and reasonable precautions against severe roof traffic, a tiled roof system will require very low maintenance. Walking on a roofing tile should be done with extreme caution. Place antennas and roof mounted equipment where a minimum of roof traffic will be necessary for servicing and maintenance. If necessary to walk on the tile surfaces, pressure should only be applied on the headlap of the tile units (lower 3-4 inches). This distributes the load near the bearing points of the tile. When painting or repairing adjoining walls or appurtenances, safely cover the tile surface with secured plywood to distribute traffic loads and prevent dirt, building materials, and paint/stain from damaging or discoloring the tile.

Weather Effects On Tile – After constant exposure to nature's elements some tile can be expected to lighten to some degree from the original color or lose some surface texture. This is due primarily to the effects of oxidation on the surface of the tile. This will not effect the structural integrity or water shedding abilities of the tile.

Vermin Screening – Metal, honeycomb plastic, foam fillers, mortar or equivalent should be considered to seal larger access areas. This will help minimize the access of birds and vermin infiltration.

NEW CONSTRUCTION

See Tables 1A, 1B and 3 for specific code related installation requirements.

Sheathing – Sheathing must be structurally adequate to support the loads involved and of a material recognized in a code evaluation report or as approved by the local building official.

Underlayment – One layer of minimum ASTM D226 Type II (No. 30 felt) (ASTM D4869 Type IV) or approved equal, with a recognized code evaluation report, shall completely cover the decking and be lapped over hips and ridges and through valleys. Underlayment shall be lapped 6" vertical (end or side lap) and 2" horizontally (head lap).

On roof slopes below 3:12 an approved multi-ply membrane roof such as a built-up roof system, applied in accordance with Table 1A, or a single-ply roof membrane assembly, or other underlayment systems approved by

the local building official, is first installed. Tile installed at less than 3:12 shall be considered decorative.

Where roof slopes fall between 3:12 and under 4:12, underlayment shall be as described in the previous paragraph, underlayments meeting ASTM D1970 (such as EPDM, Ice and Water Shield), or two layers of ASTM D226 Type II (No. 30 felt) (ASTM D4869 Type IV), installed shingle fashion, or single ply roof membrane assembly installed per code, or other approved underlayments.

In locations where the January mean temperature is 25 deg. F (-4 deg C) or less or where ice damming often occurs, the TRI/WSRCA suggests reference to the Concrete and Clay Tile Roof Design Criteria Manual for Cold and Snow Regions.

Roof Layout – To achieve the optimum performance and appearance, the roof area between the eave and ridge should be divided into equal tile courses, when possible. A minimum 3-inch overlap must be maintained for all tile, unless the tile design precludes. The actual layout

of the roof courses will be determined by the length of the specific tile being installed. Medium profiled tiles can be installed either straight or staggered bond.

Please consult with the individual manufacturer for additional information.

Batten Installation – Tiles with projecting anchor lugs that are installed on battens below 3:12 slopes shall be required to have one of the following batten systems or other methods as approved by the local building officials.

Nominal 1 inch by 2 inch, or greater, wood batten strips (See counter batten system.) installed over a counter batten system are required where slopes fall below 3:12 in order to minimize membrane penetration. Nominal 1 inch by 2 inch, or greater, wood battens are required where slopes exceed 7:12, to provide positive tile anchoring. Battens are nailed to the deck with 8D corrosion resistant box nails 24 inches on center, or No 16 gauge by 7/16 inch-crown by 1 1/2 inch long corrosion-resistant staples on 12-inch centers, allowing a 1/2" separation at the batten ends. Tile installed on roof slopes of less than 3:12

are considered decorative only and must be applied on counter battens over an approved membrane roof covering, subject to local building official approval.

Battens installed on roof slopes of 4:12 to 24:12 shall be fastened to the deck at no greater than 24 inches on center, and shall have provisions for drainage by providing 1/2-inch separation at the batten ends every 4 feet, or by shimming with a minimum 1/4" material of wood lath strips, 2-inch shims, cut from multiple layers of material, placed between the battens and deck to provide drainage beneath the battens or other methods approved by the local building official. Tile installed without projecting anchor lugs may be installed as provided above as an optional method of installation.

Counter Batten System – Counter battens 1/4" and larger in height will be installed vertically on the roof to provide the space between the battens, to which the tiles are attached, and the roof deck, thus facilitating air flow capability and moisture drainage.

consideration should be given to the size and quality of the wooden battens or sheathing boards used to support the roof tile covering.

If the battens are not strong enough to support the anticipated loading, including the roof tile and snow and/or ice, the battens could deflect between the support points

Taking the anticipated roof loading into account, design

causing roof tile breakage and/or other roof damage. Knots and knot holes weaken the batten. See Table 2 on page 12.

Note: If a counter batten system is to be installed under the underlayment, caution must be used to prevent damage to the underlayment or a reinforced underlayment will be used.

REROOFING

Roof structure must be adequate to support the anticipated roof load of tile.

Clay and concrete roofing tiles, recognized as a Class A roof assembly passing testing according to ASTM E 108, UL 790 or recognized in accordance with IRC section R902.1, will be allowed to be installed over existing asphalt shingles, plywood or OSB.

Care will be taken to ensure both horizontal and vertical alignment on the roof.

Foreign matter will be cleaned from all interlocking areas. Cracked or broken tile must be removed from the roof.

Damaged, rusted, improper flashing will be replaced.

When reroofing wood shake/shingle roofs, existing

shakes/shingles shall be removed and solid sheathing decking, tile, and flashings installed as with new construction. One layer of ASTM D226 Type II (No. 30) (ASTM D4869 Type IV) felt or approved equal underlayment shall be installed on the roof prior to application of tile. When installed over existing spaced sheathing boards, underlayment recognized by the local building code, for this type of application with, or without battens, will be used.

In lieu of such underlayment's being provided, the building official has the discretion to determine if the existing roof covering provides the required underlayment protection.

Check with local building official for any additional requirements.

Follow installation requirements as listed for new construction, once these items listed have been addressed.

VENTILATION GUIDELINES

The need for proper attic ventilation is required by most building code authorities, in accordance with the IBC and IRC. These codes recognize that the proper ventilation is a necessary component of any successful steep slope roof system.

Generally building codes require that a minimum net free

ventilating area for attic vents be a 1:150 ratio of the attic space being ventilated, the codes generally allow for the reduction of the ratio from 1:150 to 1:300 if the attic vents are a balanced system on a roof and/or a vapor retarder is installed on a ceiling assembly's warm side. Check with local building official for regional requirements.

TABLE IA		
ROOFING TILE APPLICATION¹ FOR ALL TILES		
	ROOF SLOPE 2 ½ UNITS VERTICAL IN 12 UNITS HORIZONTAL (21% Slope) TO LESS THAN 3 UNITS VERTICAL IN 12 UNITS	ROOF SLOPE 3 UNITS VERTICAL IN 12 UNITS HORIZONTAL (25% Slope) AND OVER
Deck Requirements	Sheathing must be adequate to support the loads involved, but not less than nominal 1-inch thick lumber or 15/32 inch thick plywood or other decking material recognized in a code evaluation report or by the local building official. The use of sheathing less than 15/32-inch will require supporting data.	
Underlayment In climate areas subject to wind driven snow, roof ice damming or special wind regions as shown in UBC Chapter 16, Figure 16-1 as defined by local building official.	Built-up membrane, multiple plies, three plies minimum, applied per building code requirements or code approved alternate.	Same as for other climate areas, except that extending from the eaves up the roof to a line 24" inside the exterior wall line of the building, two layers of underlayment shall be applied shingle fashion and solidly cemented together with an approved cementing material per UBC. As an option code approved self adhering membrane will be allowed.
Other Climates		Minimum one layer ASTM D226 Type II (No.30 Felt) (ASTM D4869 Type IV) head lapped 2 inches and end lapped 6 inches, or approved equal per UBC. For roof slopes of 3:12 to <4:12, two (2) layers of felt are required per IBC and IRC.
Attachment ² Type of Fasteners	Fasteners shall comply with IRC section R905.3.6 and IBC section 1507.3.6 and UBC Section 1507.3. Corrosion resistant meeting ASTM A641 Class I or approved equal, number 11 gauge diameter and of sufficient length to properly penetrate ¾" into or through the thickness of the deck or batten ² , whichever is less. The head of the nail used for tile fastening shall not be less than 5/16 inches and shall comply with ASTM F1667 for dimensional tolerances. Other fastening systems such as screws, wire, or adhesive based systems as approved by code, or local building officials will be allowed.	
Number of fasteners ^{1,2}	One fastener per tile. Flat Tile without vertical laps, two fasteners per tile. Tiles installed with projecting anchor lugs will be installed on counter battens, or other code approved methods.	Two fasteners per tile. Only one fastener on slopes of 7 units vertical in 12 units horizontal (58.3% slope) and less for tiles with installed weight exceeding 7.5 pounds per square foot, having a width no greater than 16 inches. ³
Field Tile Head Lap	3 inches minimum, unless precluded by tile design	
Flashing	Flashing shall be (No. 26 galvanized sheet gage) not less than 0.019 inch corrosion-resistant metal with a minimum of 0.90 ounce zinc/sq. ft. (total for both sides) G90 sheet metal or equal.	

¹ For jurisdictions enforcing the:

IBC: In snow areas, a minimum of two fasteners per tile are required or battens and one fastener.

IRC: In snow areas, a minimum of two fasteners per tile are required.

UBC: In snow areas, a minimum of two fasteners per tile are required, or interlocking tiles with anchor lugs engaged on battens with one fastener.

² In areas designated by the local building official as being subject to wind velocities in excess of 100 miles per hour "basic (3 second gust) wind speed" per the IBC and the IRC or where mean roof height exceeds 40 feet, but not more 60 feet above grade, all tiles shall be attached as follows;

^{2.1} The head of all tiles shall be fastened.

^{2.2} The noses of all eave course tiles shall be fastened with clips, or other methods of attachment as approved by building code officials.

^{2.3} All rake tiles shall be secured with two fasteners when required by IBC table 1507.3.7 and IRC section R905.3.7.

^{2.4} The noses of all ridge, hip and rake tiles will be set in a bead of approved roofers mastic.

^{2.5} Other methods of tile fastening will be allowed based upon submission of testing and approval of building code officials.

^{2.6} For jurisdiction enforcing IBC and IRC, see appendix B for design considerations for high wind applications.

³ On roof slopes over 24 units vertical in 12 units horizontal (200% slope), the nose end of all tiles shall be securely fastened.

TABLE IB (Alternative option) For Roof Slopes Below 4:12 See Table IA

ROOFING TILE APPLICATION FOR INTERLOCKING CONCRETE AND CLAY TILES WITH PROJECTING ANCHOR LUGS WHEN INSTALLED ON ROOF SLOPES OF 4 UNITS VERTICAL IN 12 UNITS HORIZONTAL (33% Slope) AND GREATER

4 UNITS VERTICAL IN 12 UNITS HORIZONTAL (33% Slope) and over	
Deck Requirements	Sheathing must be adequate to support the loads involved, but not less than nominal 1-inch thick lumber or 15/32- inch thick plywood or other decking material recognized in a code evaluation report or by the local building official. The use of sheathing less than 15/32- inch will require supporting data.
Underlayment In climate areas subject to wind driven snow, roof ice damming or wind regions as defined by local building codes	Solid sheathing one layer of ASTM D226 Type II (No. 30) (ASTM D4869 Type IV), or approved equal, lapped 2 inches horizontally and 6 inches vertically, except that extending from the eaves up the roof to a line 24 inches inside the exterior wall line of the building, two layers of the underlayment shall be applied shingle fashion and solidly cemented together with approved cemented material. As an option a code approved self adhering membrane may be used.
Underlayment for Other Climates	For spaced sheathing, approved reinforced membrane. For solid sheathing, a minimum single layer ASTM D226 Type II (No 30) (ASTM D4869 Type IV), or approved equal, felt lapped 2 inches horizontally and 6 inches vertically.
Attachment ¹ Type of Fasteners	Fasteners shall comply with IRC section R905.3.6 and IBC section 1507.3.6 and UBC Section 1507.3 and shall comply with ASTM F1667 for tolerances. Corrosion resistant meeting ASTM A641 Class 1 or approved equal, or number 11 gauge diameter and of sufficient length to properly penetrate 3/4" into or through the thickness of the deck or batten ³ , whichever is less. The head of the nail used for tile fastening will not be less than 5/16 inches and shall comply with ASTM F1667 for tolerances. Other fastening systems such as screws, wire or adhesive based systems as approved by code, or local building officials will be allowed. Horizontal battens are required on solid sheathing for slopes greater than 7 units vertical in 12 units horizontal (58.3% Slope). ^{1, 2}
Number of fasteners Spaced/Solid sheathing With Battens or spaced sheathing ^{1, 2}	5 units vertical in 12 units horizontal and below (42% slope), fasteners not required. Above 5 units vertical in 12 units horizontal (42% slope) to less than 12 units vertical in 12 units horizontal (100% slope), one fastener per tile every other row or every other tile in each course. Twelve units vertical in 12 units horizontal (100% Slope) to 24 units vertical in 12 units horizontal (200% slope), one fastener every tile ⁴ . All perimeter tiles require one fastener ⁵ . Tiles with installed weight less than 9 pounds per square foot require a minimum of one fastener per tile, regardless of roof slope. See current code approved evaluation report for additional installation requirement.
Solid sheathing without battens ^{1, 2}	One fastener per tile
Field Tile Head Lap	3 inches minimum unless precluded by tile design
Flashing	Flashing shall be (No. 26 galvanized sheet gage) not less than 0.019 inch corrosion-resistant metal with a minimum of 0.90 ounce zinc/sq. ft. (total for both sides) G90 sheet metal or equal.

¹ For jurisdictions enforcing the:

IBC: In snow areas, a minimum of two fasteners per tile are required or battens and one fastener.

IRC: In snow areas, a minimum of two fasteners per tile are required.

UBC: In snow areas, a minimum of two fasteners per tile are required, or interlocking tiles with anchor lugs engaged on battens with one fastener.

² In areas designated by the local building official as being subject to wind velocities in excess of 100 miles per hour "basic (3 second gust) wind speed" per the IBC and the IRC or where mean roof height exceeds 40 feet, but not more 60 feet above grade, all tiles shall be attached as follows;

2.1 The head of all tiles shall be fastened.

2.2 The noses of all eave course tiles shall be fastened with clips, or other methods of attachment as approved by building code officials.

2.3 All rake tiles shall be secured with two fasteners when required by IBC table 1507.3.7 and IRC section R905.3.7.

2.4 The noses of all ridge, hip and rake tiles will be set in a bead of approved roofers mastic.

2.5 Other methods of tile fastening will be allowed based upon submission of testing and approval of building code officials.

2.6 For jurisdiction enforcing IBC and IRC, see appendix B for design considerations for high wind applications.

³ Battens shall not be less than nominal 1-inch by 2-inch complying with IBC Chapter 23, section 2302. Provisions shall be made for drainage beneath battens by a minimum 1/4-inch riser at each nail or by 4 foot long battens with at least 1/2-inch separation between battens or other methods approved by local building officials. For jurisdictions enforcing the UBC, battens shall be fastened with approved fasteners spaced not more than 24" O.C. For jurisdictions enforcing the IBC horizontal battens are required for slopes over 7:12.

⁴ On roof slopes over 24 units vertical in 12 units horizontal (200% slope), the nose end of all tiles shall be securely fastened.

⁵ Perimeter fastening areas include three tile courses but not less than 36 inches from either side of hips or ridges and edges of eaves and gable rakes.

TABLE 2 Allowable Loads (Pounds per square foot)

(See table 3 for additional batten information)

Batten and counter batten allowable loads according to species and nominal dimensions

(Allowable load includes the total combined live and dead load)

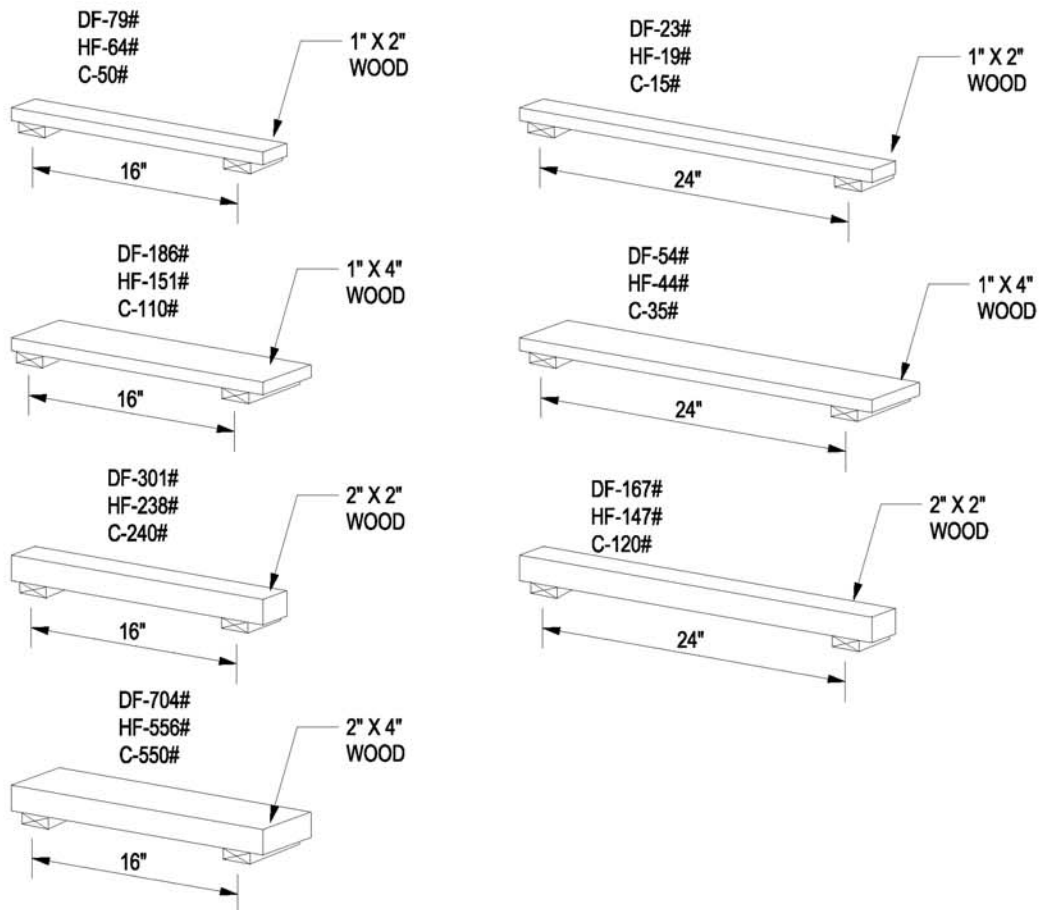

Notes: HF=Hem-Fir; DF = Douglas-Fir; C=Western Cedar (spaced at 1'0" maximum on center)

(Above values were based upon stress rated boards)

See the TRI/WSRCA Cold Weather Installation Guide for additional recommendations in cold weather applications.

Drawing shown depicts the application of all tile profiles. Unless otherwise noted it would apply to either concrete or clay tiles.

**TABLE 3
GUIDELINES FOR BATTENS & COUNTER BATTENS**

ROOF SLOPE	STANDARD REQUIREMENTS	OPTIONAL UPGRADE(S)
2 1/2 / 12 (21%) TO LESS THAN 3/12 (25%)	Counter Batten System Refer to Counter Batten Systems (Page 6) & MC-05 / MC-06A	Alternates: Corrosive resistant metal, or other man-made material that meets the allowable loads (see Table 2), in a valid and approved evaluation report ,and/or approval of the local building official.
3/12 (25%) TO 7/12 (58.3%)	Not Required See below for special climatic conditions	Nominal* 1" x 2" x 4' or less (min 1/2" separation between battens)
		Nominal* 1" x 2" x greater than 4' (Provision for drainage beneath batten with min 1/4" thick decay-resistant riser at each fastener)
		Counter Batten Refer to Counter Batten Systems (Page 6) & MC-05 / MC-06A
GREATER THAN 7/12 (58.3%)	Nominal* 1" x 2" x 4' (min 1/2" separation between battens)	Counter Batten Refer to Counter Batten Systems (Page 6) & MC-05 / MC-06A
	Nominal* 1" x 2" x 8' (Provision for drainage beneath batten with min 1/4" thick decay-resistant riser at each fastener)	Alternates: Corrosive resistant metal, or other man-made material that meets the approval of the local building official and/or a valid and recognized batten system.

Nominal:* Refer to IBC, Chapter 23 (WOOD), SECTION 2302 (DEFINITIONS).

Allowable Loads: When using counter battens, refer to Table 2 for additional load considerations.

Batten Fastening: 24" OC to the deck with 8d corrosive resistant nails.

12" OC to the deck with No 16 gauge by 7/16-inch crown by 1 1/2-inch long corrosive-resistant staples.

Once the batten is installed, it becomes part of the deck for fastening purposes.

Climatic Conditions: In dry/low humidity climates, moisture resistant battens are not required.

Consideration should be given to lower slope roofs that are susceptible to wind driven snow and rain. Optional upgrades should be considered.

Standard 4' battens fastened direct to the deck are not allowed in the Cool/Humid climate zone. Batten systems that provide drainage/air-flow (shims, counter battens or other approved systems) are required.

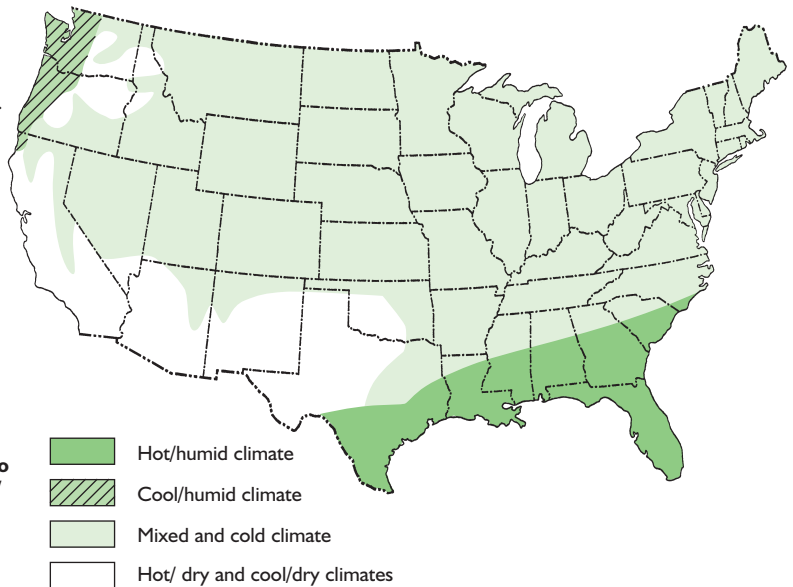

TABLE 4

ROOF SLOPE CONVERSION			
Slope/Pitch	Slope %	Ratio	Angle (deg.)
4:12	33	1:3	18.4
5:12	42	1:2.4	22.6
6:12	50	1:2	26.6
7:12	58	1:1.7	30.3
8:12	67	1:1.5	33.7
9:12	75	1:1.13	36.9
10:12	83	1:1.2	39.8
12:12	100	1:1	45.0
14:12	117	1.2:1	50.2
15:12	125	1.25:1	51.3
16:12	133	1.3:1	52.4
18:12	150	1.5:1	56.3
20:12	167	1.7:1	59.5
24:12	200	2:1	63.4
28:12	233	2.3:1	66.5
32:12	267	2.7:1	69.7
36:12	300	3:1	71.6
40:12	333	3.3:1	73.1
44:12	367	3.7:1	74.9
48:12	400	4:1	76.0

TABLE 5

METRIC CONVERSION

1 inch	25.4 mm	°Fahrenheit	$1.8 \times ^\circ\text{C} + 32$
1 foot	304.8 mm	1 pound (mass)/sq. ft.	4.88 kg/m ²
1 sq. inch	645.2 mm ²	1 yd ³	0.765 m ³
1 sq. foot	0.0929 m ²	1 inch of water	248.8 Pa
1 pound (mass)	0.453 kg	1 inch of mercury	3377 Pa
1 pound/ft.	14.594 N/m	1 mph	1.61 km/h
1 pound/sq. in.	6894 Pascals (1 pa-N/m ²)	1 gallon	3.785 liters
1 pound/sq. ft.	47.88 Pascals	1 square (100 sq. ft.)	9.28 m ²

IDENTIFICATION OF ROOF AREAS

MC-01

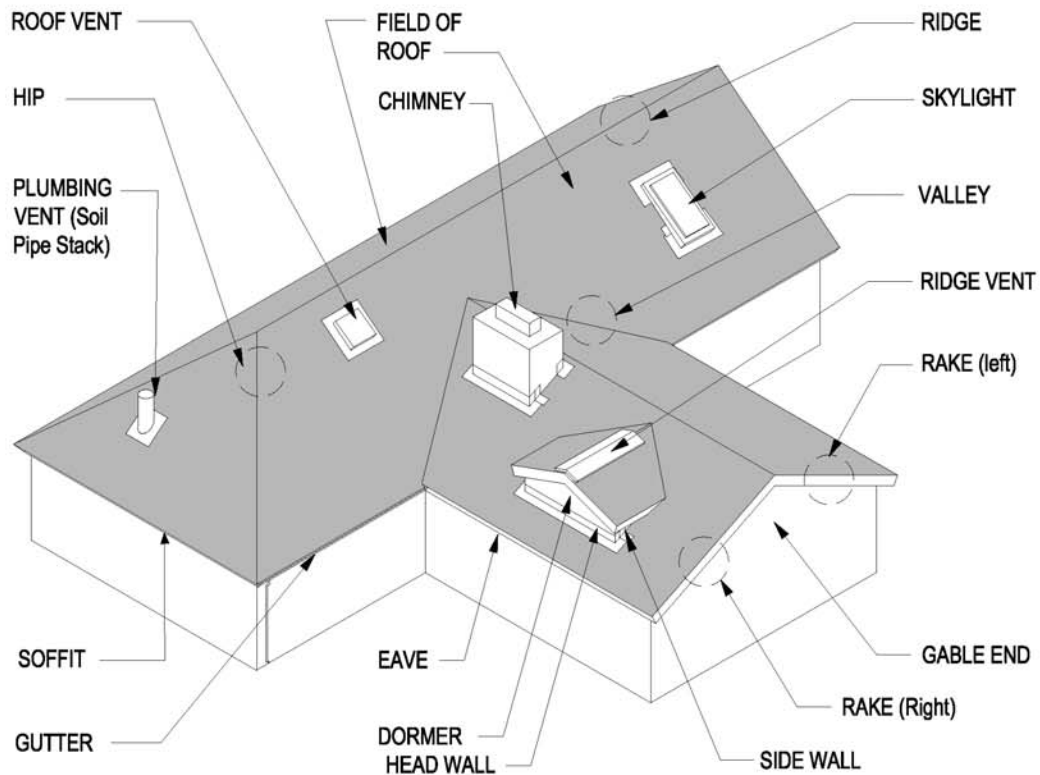

CHIMNEY: A penetration constructed of stone, masonry, prefabricated metal, or a wood frame chase, containing one or more flues, projecting through and above the roof.

DORMER: A frame projection through the sloping plane of a roof.

EAVE: A projecting edge of a roof that extends beyond the supporting wall.

FIELD OF ROOF: The central or main portion of a roof, excluding the perimeter and flashings.

GABLE: A triangular portion of the endwall of a building directly under the sloping roof and the eave line.

GUTTER: A channeled component installed along the downslope perimeter of a roof to the drain leaders or downspouts.

HIP: The inclined external angle formed by the intersection of two sloping roof planes.

HEAD WALL: Flashing installed at a horizontal roof to wall.

RAKE: The sloped edge of a roof at or adjacent to the first rafter or truss.

RIDGE: The highest point of a roof, represented by a horizontal line where two roof areas intersect, running the length of the area.

ROOF VENT: A penetration through the roof to allow ventilation.

SKYLIGHT: A roof accessory, set over an opening in the roof, designed to admit light, normally transparent, and mounted on a raised frame curb.

SOFFIT: The underside of any exterior overhanging section of the roof eave.

SOIL PIPE STACK: A sanitation pipe that penetrates the roof; used to vent plumbing fixture(s).

VALLEY: The internal angle formed by the intersection of two sloping roof planes.

Drawing shown depicts the application of all tile profiles. Unless otherwise noted it would apply to either concrete or clay tiles.

SINGLE-LAYER UNDERLAYMENT

MC-01A

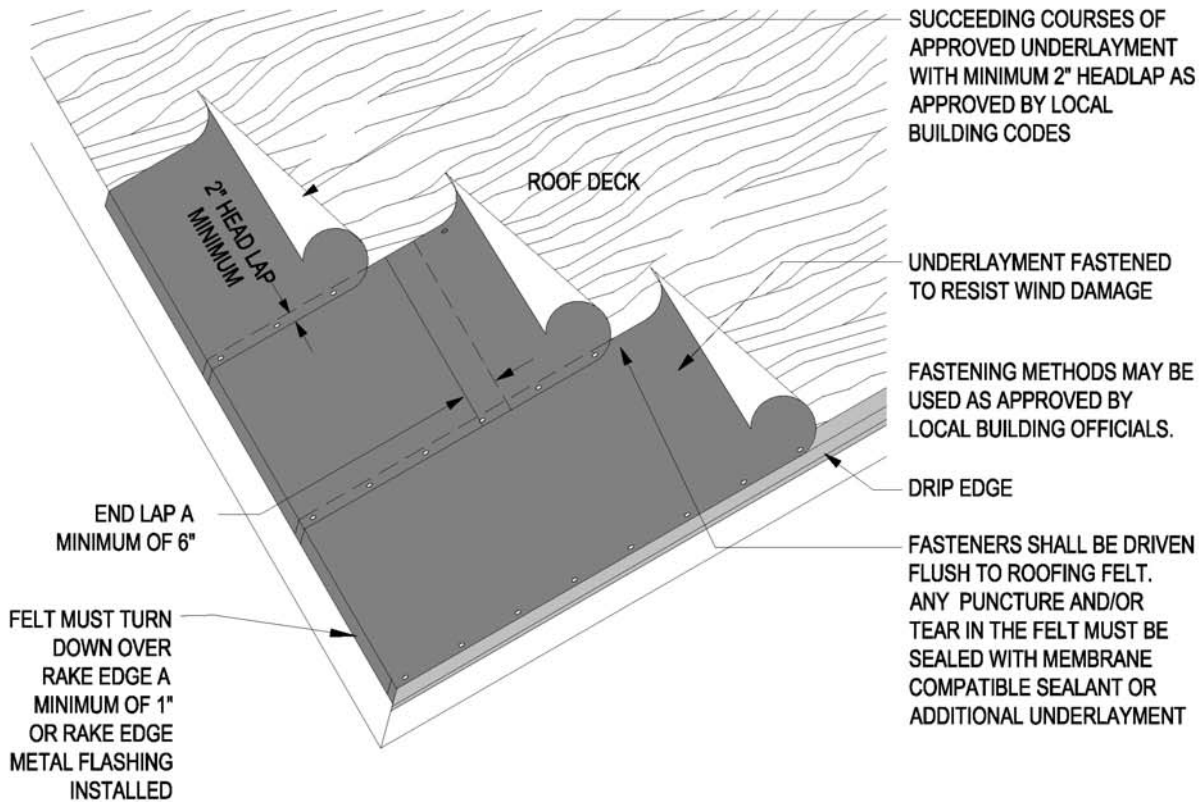

Note:

Roof slopes below 3:12 shall have an approved built-up roof membrane, applied in accordance with Table 1A, or a single ply roof membrane system, or other multi-ply underlayment system(s) approved by the local building official.

ICE DAM PROTECTION WHERE REQUIRED. SEE TABLES 1A & 1B

Notes:

1. Ensure that the roof deck is properly fastened, clean and smooth before underlayment and roof tiles are applied.
2. Verify that the roof deck has no significant delamination, warpage, etc. Check for roof deck decay or damage.
3. Make sure repairs are made to the roof deck as necessary to meet local building codes.
4. Most problems with water-shedding roof installations occur from water that migrates through improper flashing of the tile, wind-driven rain or ice damming. Because of this possibility, the underlayment is critical to the success of the roof system.
5. For recommended underlayment and fastening requirements, see Table 1A and 1B.
6. Underlayment should extend a minimum of 4" up vertical wood blocking or wall. Laps should be a minimum of 6" endlap (vertical lap) and 2" headlap (horizontal lap.)

Drawing shown depicts the application of all tile profiles. Unless otherwise noted it would apply to either concrete or clay tiles.

DOUBLE LAYER UNDERLAYMENT

(Required for 3:12 < Roof Slope < 4:12, Optional Upgrade 4:12 And Above)

MC-01B

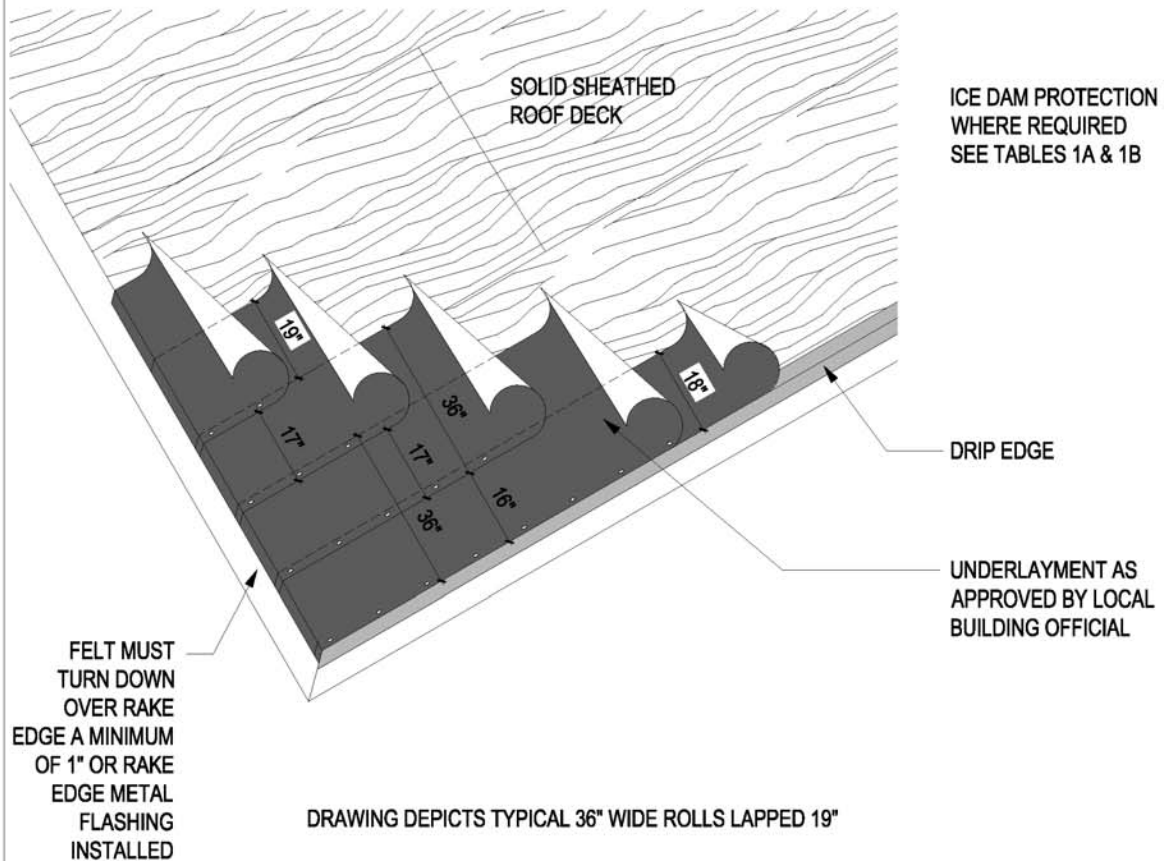

DRAWING DEPICTS TYPICAL 36" WIDE ROLLS LAPPED 19"

Notes:

1. Ensure that the roof deck is properly fastened, clean and smooth before underlayment and roof tiles are applied.
2. Verify that the roof deck has no significant delamination, warpage, etc. Check for roof deck rot or damage.
3. Make sure repairs are made to the roof deck as necessary to meet local building codes.
4. Apply a half sheet parallel to eave. Fasten underlayment sufficient to hold the felt in place.
5. Completely cover the starter sheet with a full-width sheet.
6. Most problems with water-shedding roof installations occur from water that migrates through improper flashing of the tile, wind-driven rain or ice damming. Because of this possibility, the underlayment is critical to the success of the roof system.
7. Underlayment shall extend a minimum of 4" up vertical wood blocking or wall.
8. Lap succeeding sheets to ensure double layers over entire roof. End laps (vertical laps) shall be a minimum of 6".

Drawing shown depicts the application of all tile profiles. Unless otherwise noted it would apply to either concrete or clay tiles.

Appendix A

TILE PENETRATION FLASHING

(Shows Required Two-Step Deck And Tile Flashing)

MC-02

STEP 1: DECK FLASHING

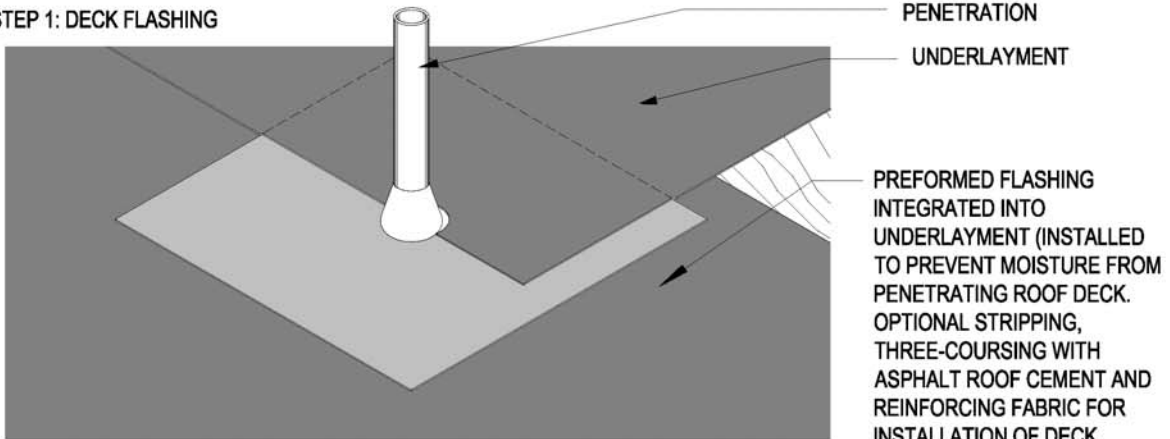

STEP 2: TILE FLASHING

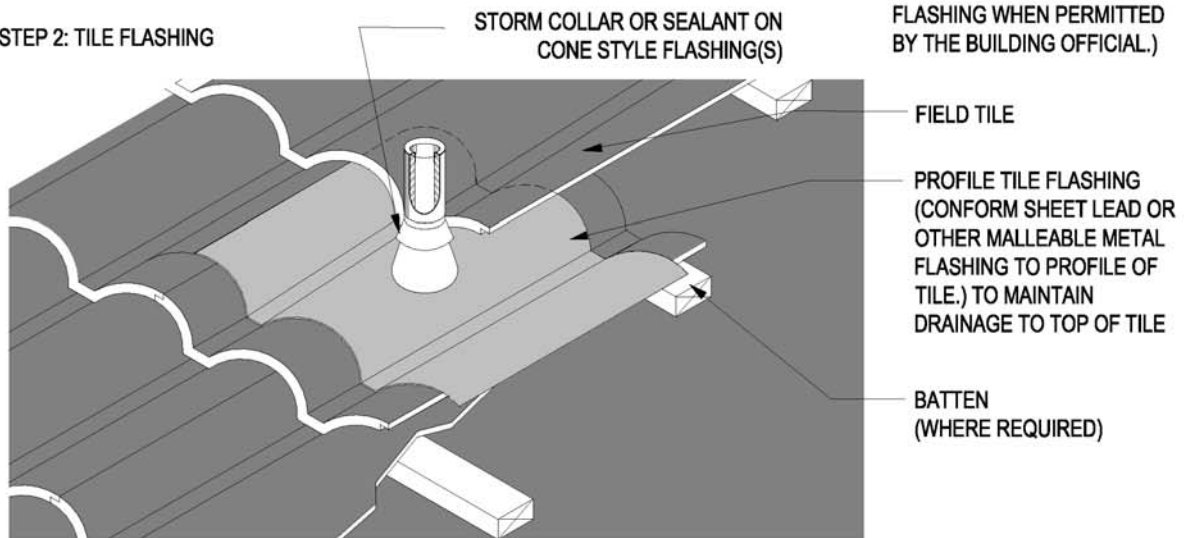

ALL PENETRATIONS SHOULD BE LOCATED IN SUCH A MANNER AS TO NOT IMPEDE FLASHINGS AT ROOF TRANSITION.

Notes:

1. For recommended underlayment and fastening requirement, see Table 1A and 1B.
2. All penetrations require a deck flashing and tile flashing.
3. Tile flashings shall extend onto the tile a minimum of 4" on flat tile and a minimum of 1" past the crown of a profiled tile.
4. Dimensions shown are minimums and are intended to be approximate to allow for reasonable tolerances due to field conditions.
5. For flat tile, rigid flashing materials may be used.

Drawing shown depicts the application of all tile profiles. Unless otherwise noted it would apply to either concrete or clay tiles.

VALLEY UNDERLAYMENTS

WOVEN UNDERLAYMENT (Metal Flashing Not Shown)

MC-03

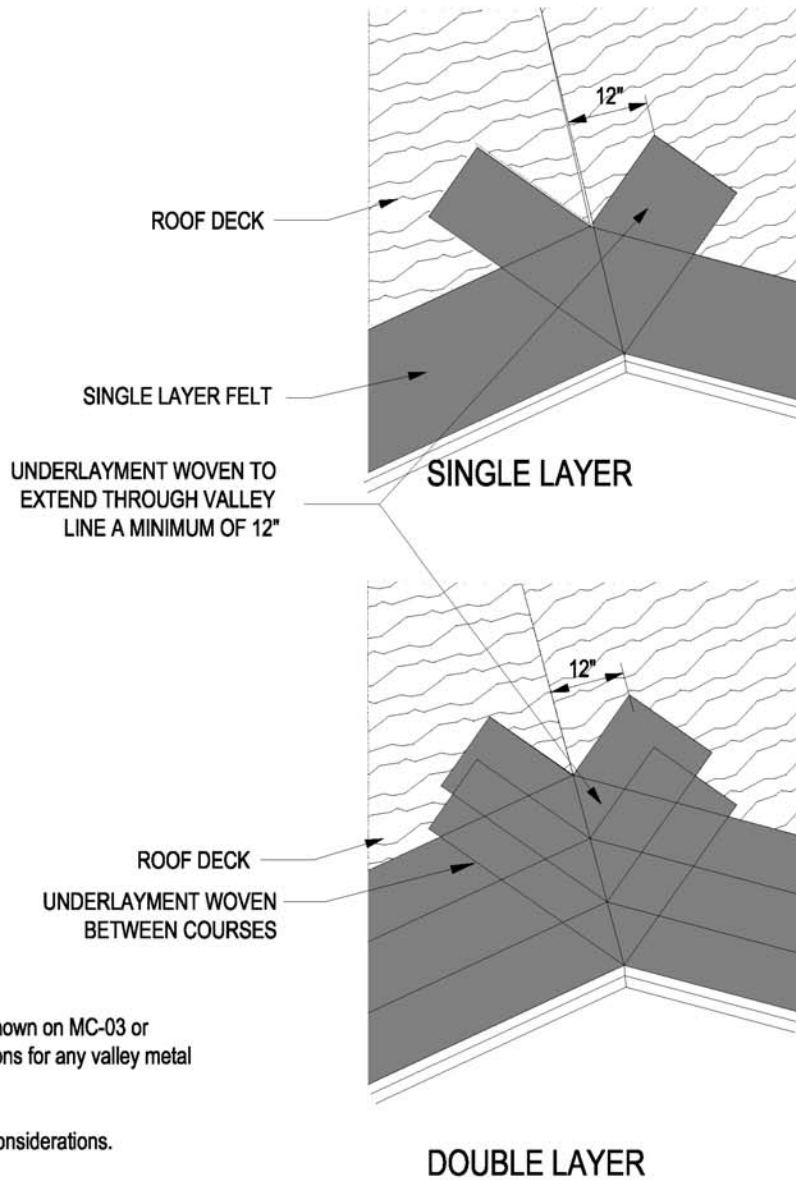

Note:
The underlayment options shown on MC-03 or MC-03A are acceptable options for any valley metal configuration.

See MC12-B for additional considerations.

Notes:

1. For recommended underlayment and fastening requirement, see Table 1A and 1B.

Drawing shown depicts the application of all tile profiles. Unless otherwise noted it would apply to either concrete or clay tiles.

Appendix A

VALLEY UNDERLAYMENTS

MC-03A

OVERLAPPING UNDERLAYMENT

THIS METHOD NOT TO BE USED WITH STANDING HEM VALLEY METAL

36" SWEAT / BLEEDER SHEET

ROOF DECK

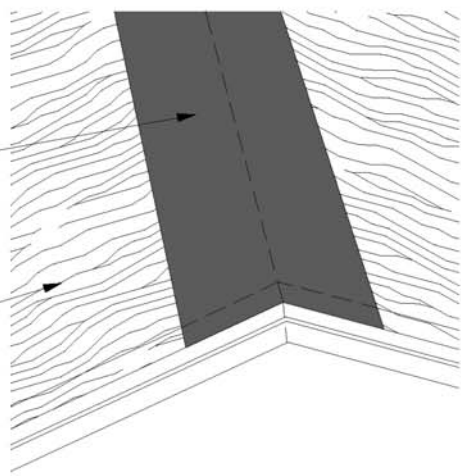

UNDERLAYMENT TO LAP OVER VALLEY METAL A MINIMUM OF 2".

Note:
 The underlayment options shown in MC-03 or MC-03A are acceptable options for any code approved metal. See MC-12B for additional considerations

ROOF DECK

VALLEY FLASHING

OPTIONAL: SELF-ADHERING POLYMER MODIFIED ASPHALT MEMBRANE ON EACH SIDE TO COVER FLASHING FLANGE

CUT TOP CORNER OF UNDERLAYMENT TO INSURE PROPER DIVERSION OF WATER INTO THE VALLEY METAL

ROOF UNDERLAYMENT

VALLEY FLASHING (EXTEND ENTIRE WIDTH OF VALLEY METAL BEYOND ROOF EDGE)

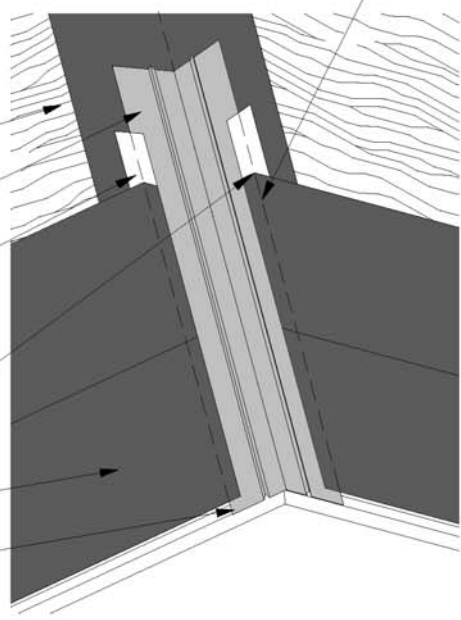

Notes:

1. For recommended underlayment and fastening requirement, see Table 1A and 1B.

Drawing shown depicts the application of all tile profiles. Unless otherwise noted it would apply to either concrete or clay tiles.

BATTEN LAYOUT OPTIONS

(FOR TILES WITH PROTRUDING ANCHOR LUGS)

MC-04

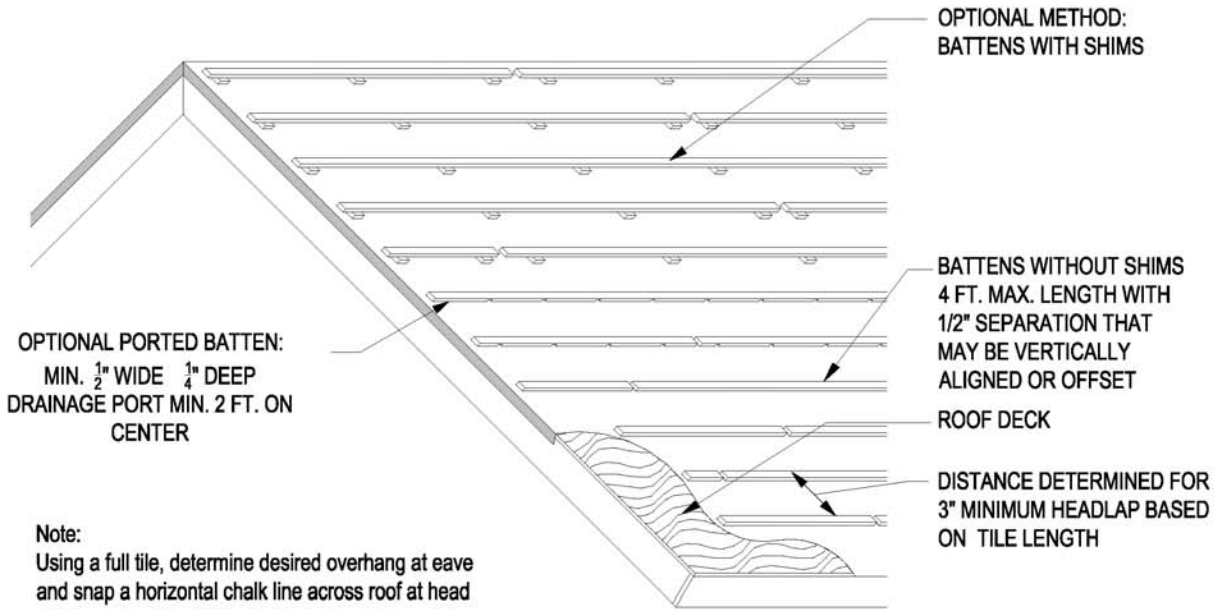

Note:
Using a full tile, determine desired overhang at eave and snap a horizontal chalk line across roof at head of tile or top of batten. Use of rain gutters and eave closures should be considered in determining tile overhang.

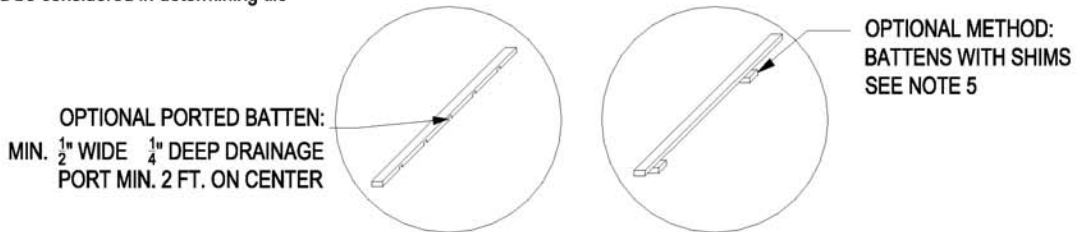

Notes:

1. For recommended underlayment and fastening requirement, see Table 1A and 1B.
2. Battens shall not be less than nominal 1-inch by 2-inch or other code approved products.
3. Battens shall be no longer than 48" and be separated with 1/2" minimum gaps at ends to allow drainage. An alternate method permits use of longer batten strips with shims of minimum 1/4" thick decay-resistant material (e.g. asphalt shingle, wood strips or cap sheet) at each fastener to provide drainage, or other methods approved by local building officials.
4. Battens for tiles with protruding anchor lugs are optional for slopes between 3:12 and 7:12. Direct deck nailing attachment of tile will be per local building code.
5. Consideration should be given to climate and roof orientation to determine if it is beneficial to specify/use vertical battens over underlayment, with horizontal battens secured over the vertical battens.
6. See Table 2 and Table 3 for additional batten considerations.

Drawing shown depicts the application of all tile profiles. Unless otherwise noted it would apply to either concrete or clay tiles.

COUNTERBATTEN INSTALLATION SYSTEM

MC-05

Note:
Consideration should be given to climate and roof orientation to determine if it is beneficial to specify/use vertical battens over underlayment, with horizontal battens secured over the vertical battens.

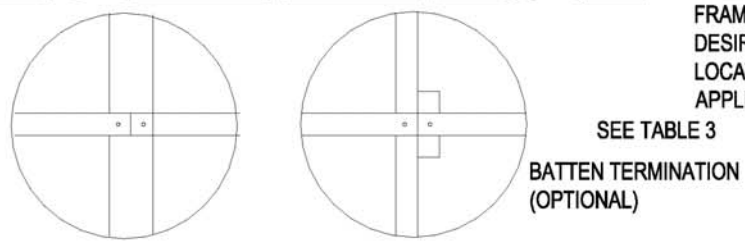
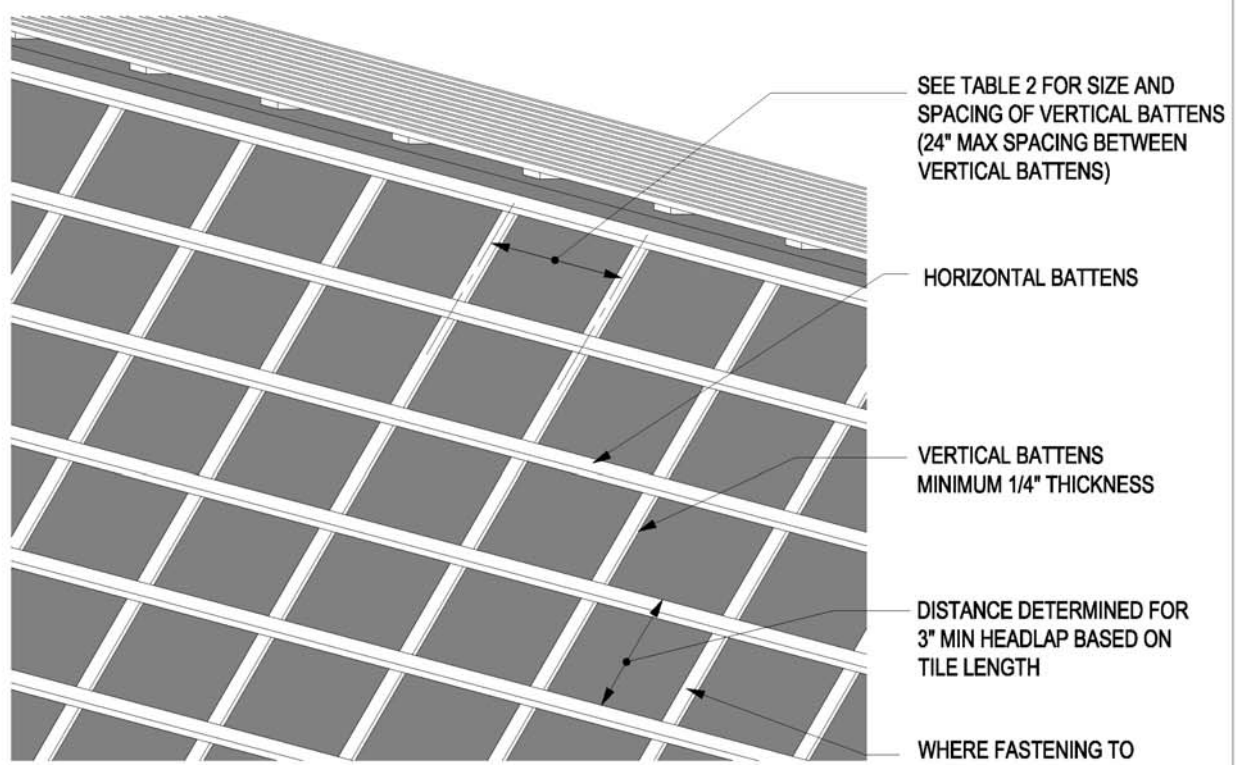

- Notes:
1. For recommended underlayment and fastening requirement, see Table 1A and 1B.
 2. Horizontal batten shall be sufficient thickness to fully engage protruding anchor lugs of the tile.
 3. See Table 2 and 3 for additional information
 4. Fasten battens a minimum of 24" on center with minimum 8d corrosion-resistant nails penetrating through decking or into structural framing. Batten attachment at 12" on center with staples a minimum of 1-1/2" long 7/16" crown, No 16 gauge corrosion-resistant allowing for 3/4" penetration into roof deck or protrude min. 1/4" through the sheathing which ever is less or on 24" centers if fastened directly to structural framing.

Drawing shown depicts the application of all tile profiles. Unless otherwise noted it would apply to either concrete or clay tiles.

VERTICAL BATTENS - FOR DEEP TROUGH VALLEY

MC-06

ANY VALLEY FLASHING WITH OUTSIDE EDGES RAISED TO THE HEIGHT OF THE VERTICAL OR HORIZONTAL BATTENS

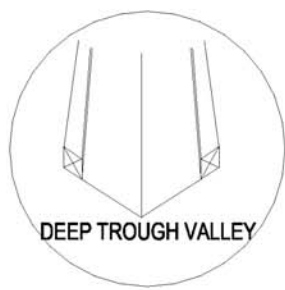
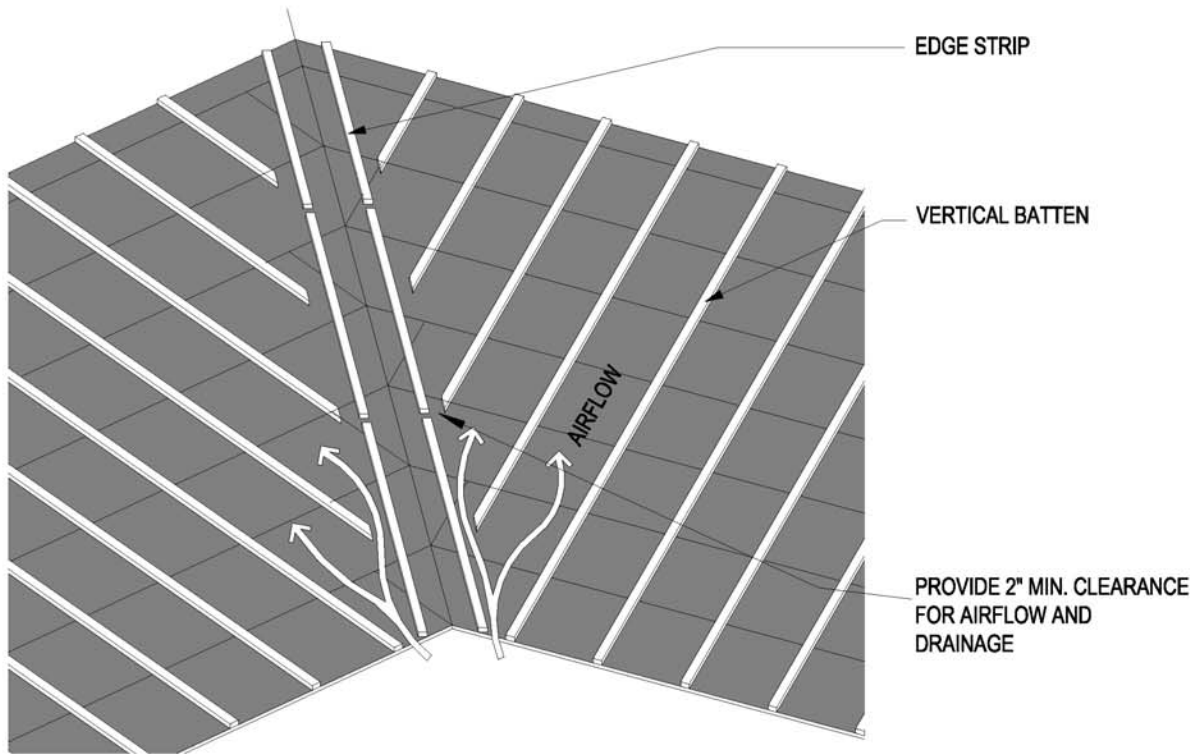

REFER TO MC-03 FOR WOVEN UNDERLAYMENT
 REFER TO MC-17 FOR FINISH DETAIL
 REFER TO MC-17B FOR DEEP TROUGH DETAIL

Notes:

1. For recommended underlayment and fastening requirement, see Table 1A and 1B.
2. Consideration should be given to climate and roof orientation to determine if it is beneficial to specify/use vertical battens over underlayment, with horizontal battens secured over the vertical battens. See table 3 for additional considerations.

Drawing shown depicts the application of all tile profiles. Unless otherwise noted it would apply to either concrete or clay tiles.

Appendix A

VERTICAL BATTENS - FOR STANDARD VALLEY AND HIP

MC-06A

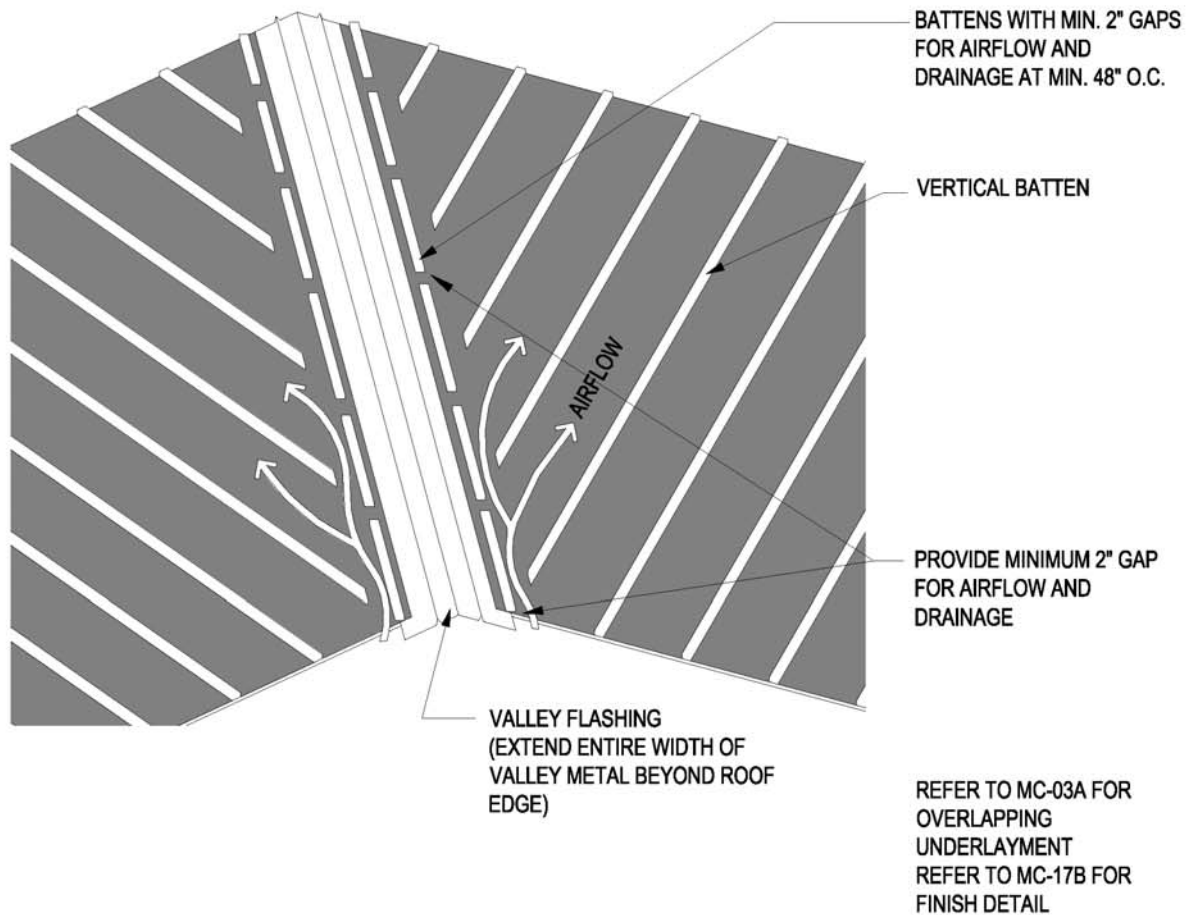

Notes:

1. For recommended underlayment and fastening requirement, see Table 1A and 1B.
2. Horizontal battens shall not be less than nominal 1"x2" or code approved equal.
3. Consideration should be given to climate and roof orientation to determine if it is beneficial to specify/use vertical battens over underlayment, with horizontal battens secured over the vertical battens.
4. See Table 2 and Table 3 for additional considerations.

Drawing shown depicts the application of all tile profiles. Unless otherwise noted it would apply to either concrete or clay tiles.

ESTABLISHING VERTICAL ALIGNMENT

MC-07

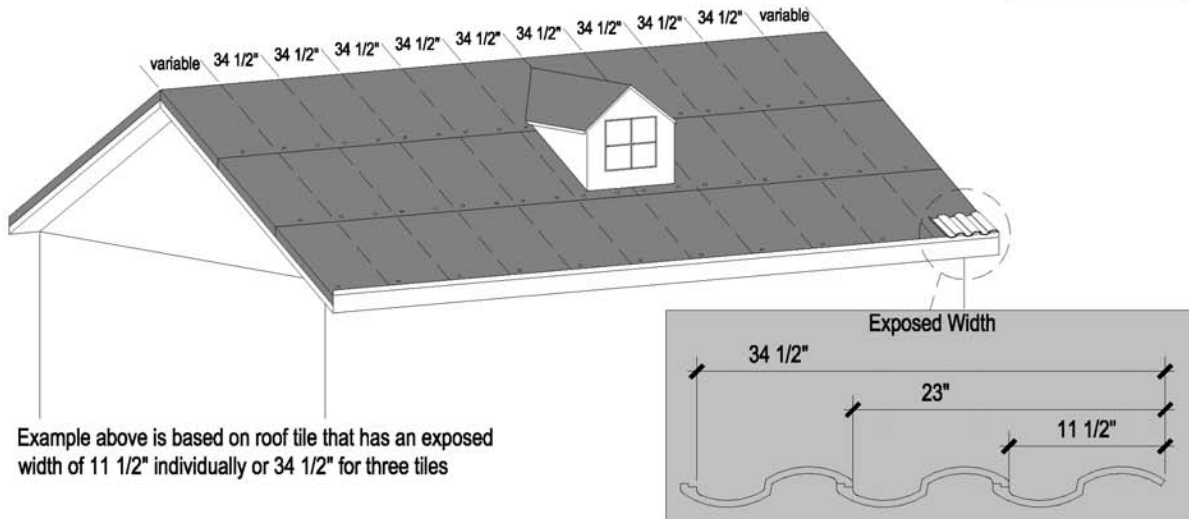

Example above is based on roof tile that has an exposed width of 11 1/2" individually or 34 1/2" for three tiles

Vertical alignment on interlocking tiles is, for the most part, controlled by the natural seat of the interlocking channels of the adjacent tiles. It is important however to establish a true vertical alignment prior to application of field tiles to assure a symmetrical installation. Proper roof layout greatly enhances the appearance and performance of the installed roof and serves to simplify and speed the application of the tile. A few minutes devoted to layout at the beginning of the job can result in significant savings of time and effort as the job progresses.

On a gable roof installation, the first vertical guideline is established by installing the first three tiles of the eave course and measuring the distance from the leading edge of the third tile back to the rake edge. This increment is then marked at the ridge course and a chalk line is snapped to delineate the vertical guide.

The exposed width dimension of the tile is then determined and measured from the vertical guide as frequently as needed to maintain proper alignment. Most often this measurement is marked in three-tile increments.

Vertical lines shall be perpendicular to the eave

Mark a point at the eave line as close to the center of the hip section as possible. Measure a point away from either side of the center point (5'-10' if possible) making sure that both marks are the same distance from the center line. Using a tape measure or lines of exactly the same length. Swing an arc from each mark to intersect as high on the hip as possible. The intersection point of the arcs represent the high point of the vertical line above the mark made near the center of the eave line. A chalk line may be snapped to provide vertical reference. Incremental measurements may then be taken in either direction from this center line to provide guidelines for vertical alignment.

On small hip sections, careful attention to horizontal alignment and proper tile placement is usually adequate to maintain vertical alignment.

On larger roof sections, it is helpful to establish solid vertical alignment to ensure uniform appearance and ease of application.

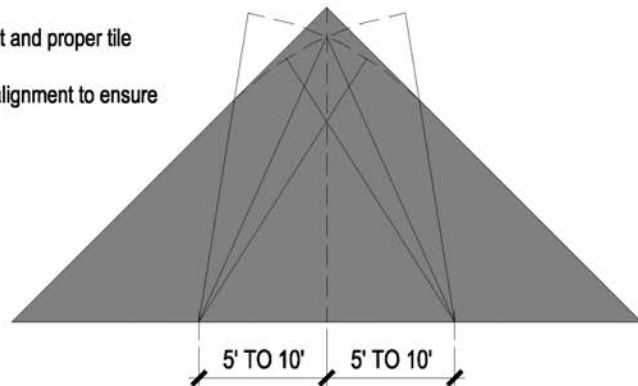
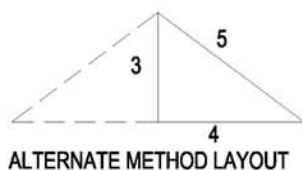

Drawing shown depicts the application of all tile profiles. Unless otherwise noted it would apply to either concrete or clay tiles.

ROOF LAYOUT

UTILIZING SPECIALLY MARKED MEASURING TAPE

MC-08

To achieve optimum beauty, the area between the eave and ridge should be divided into equal tile courses, when possible. Minimum 3" overlap must be maintained for all tiles unless design of tile precludes. (See MC-04 for batten applications)

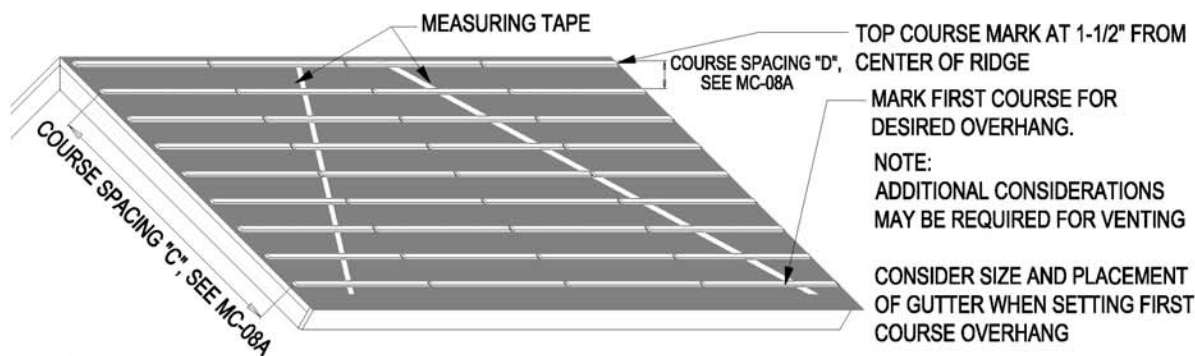

Notes:

1. Using a full tile, determine desired overhang at eave and snap horizontal chalk line across roof at head end of tile or top of batten. Use of rain gutters and eave closures should be considered in determining tile overhang.
2. Snap a horizontal chalk line at the top of the roof 1-1/2" from the center of the ridge. (Adjust for direct deck)
3. With measuring tape, marked for maximum "exposed length" of tile being installed, measure vertically from the course nearest the ridge at either end of the roof. (i.e. 14" for a 17" length tile)
4. If a mark on your tape does not fall exactly upon top line, move the tape to the left or right until the next mark intersects the line.
5. Mark the deck at every mark on the tape.
6. Repeat this process at other end of roof.
7. Snap lines between marks on the deck. All courses will be equal with minimum recommended headlap maintained.
8. Repeat above steps on all roof planes.
9. Nail top of battens or tiles at each horizontal line.

ROOF LAYOUT FOR CLAY DIAGONAL CUT ONE-PIECE S TILE

Horizontal Lay-Out

1. Using a full tile, determine desired overhang at eave and snap a horizontal chalk line across roof at head end of tile. Use of rain gutters and eave closures shall be considered in determining tile overhang.
2. At the top of the roof deck, mark a reference point by measuring 1 1/2" from the center of the ridge, plus the distance of one full course (i.e. 15" for a 18" length tile).
3. Measure up the roof slope to the reference point and divide by the manufacturer's maximum exposure in an effort to determine if the roof section will terminate with a full tile. Mark roof deck for each course of tile and snap chalk lines over entire section.
4. If roof section does not terminate with a full tile at the ridge, decrease the course exposure in small increments (typically 1/4") in attempt to finish with a full tile at the ridge (see note below).
5. If the last course does not terminate with a full tile, cut to dimension, as required and fasten with mechanical fastener or other approved fastening method.

Vertical Lay-Out

1. To ensure proper vertical alignment, determine the manufacturer's stated maximum on-center spacing requirements and snap chalk lines as a reference point, typically the inside of the tile.
2. For gable end roof sections, determine the proper distance from the left and right rakes and mark the eave and ridge section to align the edge of the tiles.
3. Measure between the two marks and divide by manufacturer's stated maximum on-center spacing. If required, decrease the on-center spacing, slightly in an effort to terminate with a full tile at gable end(s). Ensure that the installed tile are within the manufacturer's minimum/maximum on-center spacing requirements.

Note: Tiles are allowed, by ASTM C1167/C1492 for a plus or minus 5% variance from the manufacturer's stated "nominal dimensions". It is the installer's responsibility to verify the "delivered" roof tiles dimensions prior to commencing with roof layout and to ensure that the tile is installed within the manufacturers minimum headlap and on-center spacing requirements. Most diagonal-cut tiles will allow slight course exposure adjustments typically 1/4" per tile.

Drawing shown depicts the application of all tile profiles. Unless otherwise noted it would apply to either concrete or clay tiles.

ROOF LAYOUT - QUICK REFERENCE

MC-08A

Course Spacing Table - For Tiles 16 1/2" to 17" in Length

To achieve optimum beauty, the area between the eave and ridge should be divided into equal tile courses, when possible. Minimum 3" overlap must be maintained for all tiles unless design of tile precludes.

17" - ONLY

16 1/2" - NOT TO EXCEED 13 1/2"

Course Spacing "C" from MC-08

12 1/2"	12 5/8"	12 3/4"	12 7/8"	13"	13 1/8"	13 1/4"	13 3/8"	13 1/2"	13 5/8"	13 3/4"	13 7/8"	14"
2' 1"	2' 1 1/4"	2' 1 1/2"	2' 1 3/4"	2' 2"	2' 2 1/4"	2' 2 1/2"	2' 2 3/4"	2' 3"	2' 3 1/4"	2' 3 1/2"	2' 3 3/4"	2' 4"
3' 1 1/2"	3' 1 7/8"	3' 2 1/4"	3' 2 5/8"	3' 3"	3' 3 3/8"	3' 3 3/4"	3' 4 1/8"	3' 4 1/2"	3' 4 7/8"	3' 5 1/4"	3' 5 5/8"	3' 6"
4' 2"	4' 2 1/2"	4' 3"	4' 3 1/2"	4' 4"	4' 4 1/2"	4' 5"	4' 5 1/2"	4' 6"	4' 6 1/2"	4' 7"	4' 7 1/2"	4' 8"
5' 2 1/2"	5' 3 1/8"	5' 3 3/4"	5' 4 3/8"	5' 5"	5' 5 5/8"	5' 6 1/4"	5' 6 7/8"	5' 7 1/2"	5' 8 1/8"	5' 8 3/4"	5' 9 3/8"	5' 10"
6' 3"	6' 3 3/4"	6' 4 1/2"	6' 5 1/4"	6' 6"	6' 6 3/4"	6' 7 1/2"	6' 8 1/4"	6' 9"	6' 9 3/4"	6' 10 1/2"	6' 11 1/4"	7' 0"
7' 3 1/2"	7' 4 3/8"	7' 5 1/4"	7' 6 1/8"	7' 7"	7' 7 7/8"	7' 8 3/4"	7' 9 5/8"	7' 10 1/2"	7' 11 3/8"	8' 1 1/4"	8' 1 5/8"	8' 2"
8' 4"	8' 5"	8' 6"	8' 7"	8' 8"	8' 9"	8' 10"	8' 11"	9' 0"	9' 1"	9' 2"	9' 3"	9' 4"
9' 4 1/2"	9' 5 5/8"	9' 6 3/4"	9' 7 7/8"	9' 9"	9' 10 1/8"	9' 11 1/4"	10' 3/8"	10' 1 1/2"	10' 2 5/8"	10' 3 3/4"	10' 4 7/8"	10' 6"
10' 5"	10' 6 1/4"	10' 7 1/2"	10' 8 3/4"	10' 10"	10' 11 1/4"	11' 1/2"	11' 1 3/4"	11' 3"	11' 4 1/4"	11' 5 1/2"	11' 6 3/4"	11' 8"
11' 5 1/2"	11' 6 7/8"	11' 8 1/4"	11' 9 5/8"	11' 11"	12' 3/8"	12' 1 3/4"	12' 3 1/8"	12' 4 1/2"	12' 5 7/8"	12' 7 1/4"	12' 8 5/8"	12' 10"
12' 6"	12' 7 1/2"	12' 9"	12' 10 1/2"	13' 0"	13' 1 1/2"	13' 3"	13' 4 1/2"	13' 6"	13' 7 1/2"	13' 9"	13' 10 1/2"	14' 0"
13' 6 1/2"	13' 7 7/8"	13' 9 3/4"	13' 11 3/8"	14' 1"	14' 2 5/8"	14' 4 1/4"	14' 5 7/8"	14' 7 1/2"	14' 9 1/8"	14' 10 3/4"	15' 3/8"	15' 2"
14' 7"	14' 8 3/4"	14' 10 1/2"	15' 1/4"	15' 2"	15' 3 3/4"	15' 5 1/2"	15' 7 1/4"	15' 9"	15' 10 3/4"	16' 1/2"	16' 2 1/4"	16' 4"
15' 7 1/2"	15' 9 3/8"	15' 11 1/4"	16' 1 1/8"	16' 3"	16' 4 7/8"	16' 6 3/4"	16' 8 5/8"	16' 10 1/2"	17' 3/8"	17' 2 1/4"	17' 4 1/8"	17' 6"
16' 8"	16' 10"	17' 0"	17' 2"	17' 4"	17' 6"	17' 8"	17' 10"	18' 0"	18' 2"	18' 4"	18' 6"	18' 8"
17' 8 1/2"	17' 10 5/8"	18' 3/4"	18' 2 7/8"	18' 5"	18' 7 1/8"	18' 9 1/4"	18' 11 3/8"	19' 1 1/2"	19' 3 5/8"	19' 5 3/4"	19' 7 7/8"	19' 10"
18' 9"	18' 11 1/4"	19' 1 1/2"	19' 3 3/4"	19' 6"	19' 8 1/4"	19' 10 1/2"	20' 3/4"	20' 3"	20' 5 1/4"	20' 7 1/2"	20' 9 3/4"	21' 0"
19' 9 1/2"	19' 11 7/8"	20' 2 1/4"	20' 4 5/8"	20' 7"	20' 9 3/8"	20' 11 3/4"	21' 2 1/8"	21' 4 1/2"	21' 6 7/8"	21' 9 1/4"	21' 11 5/8"	22' 2"
20' 10"	21' 1 1/2"	21' 3"	21' 5 1/2"	21' 8"	21' 10 1/2"	22' 1"	22' 3 1/2"	22' 6"	22' 8 1/2"	22' 11"	23' 1 1/2"	23' 4"
21' 10 1/2"	22' 1 1/8"	22' 3 3/4"	22' 6 3/8"	22' 9"	22' 11 5/8"	23' 2 1/4"	23' 4 7/8"	23' 7 1/2"	23' 10 1/8"	24' 3/4"	24' 3 3/8"	24' 6"
22' 11"	23' 1 3/4"	23' 4 1/2"	23' 7 1/4"	23' 10"	24' 3/4"	24' 3 1/2"	24' 6 1/4"	24' 9"	24' 11 3/4"	25' 2 1/2"	25' 5 1/4"	25' 8"
23' 11 1/2"	24' 2 5/8"	24' 5 1/4"	24' 8 1/8"	24' 11"	25' 1 7/8"	25' 4 3/4"	25' 7 5/8"	25' 10 1/2"	26' 1 3/8"	26' 4 1/4"	26' 7 1/8"	26' 10"
25' 0"	25' 3"	25' 6"	25' 9"	26' 0"	26' 3"	26' 6"	26' 9"	27' 0"	27' 3"	27' 6"	27' 9"	28' 0"
26' 1 1/2"	26' 3 5/8"	26' 6 3/4"	26' 9 7/8"	27' 1"	27' 4 1/8"	27' 7 1/4"	27' 10 3/8"	28' 1 1/2"	28' 4 5/8"	28' 7 3/4"	28' 10 7/8"	29' 2"
27' 1"	27' 4 1/4"	27' 7 1/2"	27' 10 3/4"	28' 2"	28' 5 1/4"	28' 8 1/2"	28' 11 3/4"	29' 3"	29' 6 1/4"	29' 9 1/2"	30' 3/4"	30' 4"
28' 1 1/2"	28' 4 7/8"	28' 8 1/4"	28' 11 5/8"	29' 3"	29' 6 3/8"	29' 9 3/4"	30' 1 1/8"	30' 4 1/2"	30' 7 7/8"	30' 11 1/4"	31' 2 5/8"	31' 6"
29' 2"	29' 5 1/2"	29' 9"	30' 1 1/2"	30' 4"	30' 7 1/2"	30' 11"	31' 2 1/2"	31' 6"	31' 9 1/2"	32' 1"	32' 4 1/2"	32' 8"

Course Spacing "D" from MC-08

Notes:

- Using a full tile, determine desired overhang at eave and snap horizontal chalk line across roof at head end of tile on direct deck or top of batten for batten installations. Use of rain gutters and eave closures should be considered in determining tile overhang.
- Snap a horizontal chalk line at the top of the roof 1-1/2" from the center of the ridge. (Adjust for direct deck)
- In spacing guide, find column containing nearest figure to the measurement between eave and ridge course.
- Mark both ends of roof at course spacing shown in column.
- Snap chalk lines across roof at course markings.
- Nail top of battens to chalk line.

Drawing shown depicts the application of all tile profiles. Unless otherwise noted it would apply to either concrete or clay tiles.

Appendix A

LOADING GUIDE (EXAMPLE)

MC-09

The method of roof loading shown on this page represents the method of tile placement for efficient application, but is not intended to suggest that this is the only method that will work. Each applicator will have personal preferences for the stack location and spacing. The important aspect of the tile loading is to spread the load evenly across the roof while using the proper increments that assure that the proper amount of tile is loaded on roof.

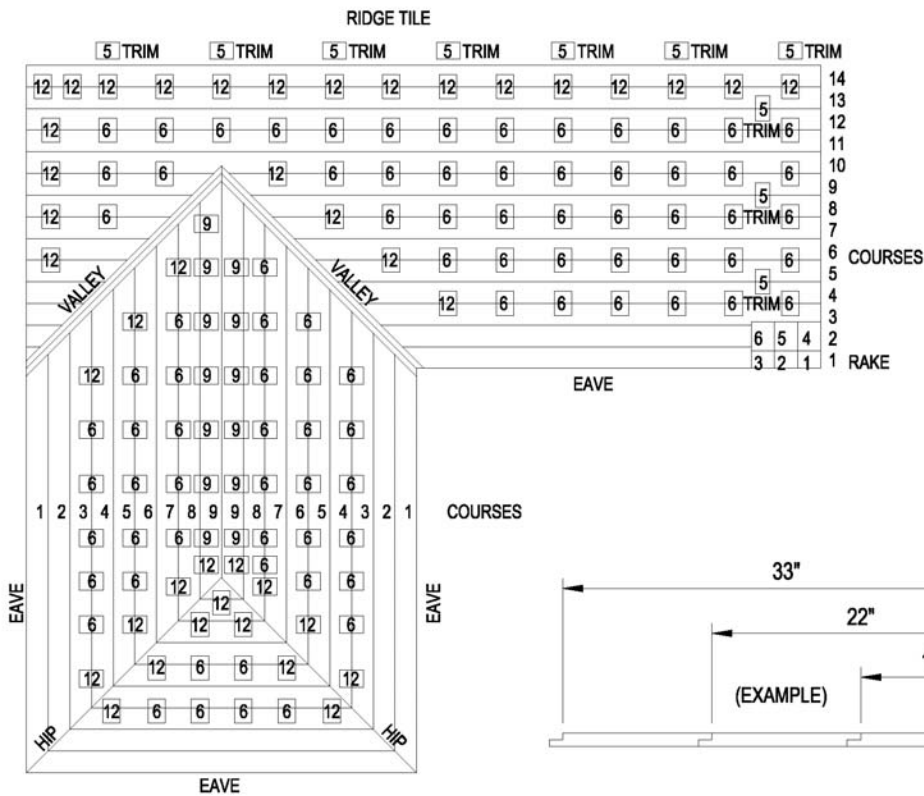

1. Course lines should be measured and chalked according to the roof layout recommendations before loading the tile.
2. Determine the approximate number of tiles needed for each section of roof.
3. Spacing of the tile stacks is determined by the width of the exposed tile times the number of tiles being fed per course, e.g. in the attached schematic, each stack of tiles will feed two courses, three tiles wide. If each tile is exposed 11", then the stack will be placed 33" o.c. If the stack feeds three courses, two tiles wide, then the stack would be 22" o.c.
4. Starting with the third course from the eave, and continuing with alternate courses, distribute tiles (usually 6 per stack) over the roof leaving approximately 20" from gable ends and between stacks.
5. When total number of courses is an even number, stack 12 tiles on ridge stacks. When total number of courses is an odd number, stack 9 tiles on ridge stack.
6. On right side of the hips and valleys, stack 12 tiles. Maintain at least 24" between tile stacks and left side of valley. Reverse for tiles layed left to right.
7. Distribute trim tiles when loading field tiles. Trim tiles are in stacks of 5 at 70" o.c. Load ridge tile on side of roof to be applied last.
8. To achieve a pleasant, random blend of color for your job, care should be taken upon loading to mix the tiles.

Drawing shown depicts the application of all tile profiles. Unless otherwise noted it would apply to either concrete or clay tiles.

DOWN SLOPE EAVE DETAILS

MC-10

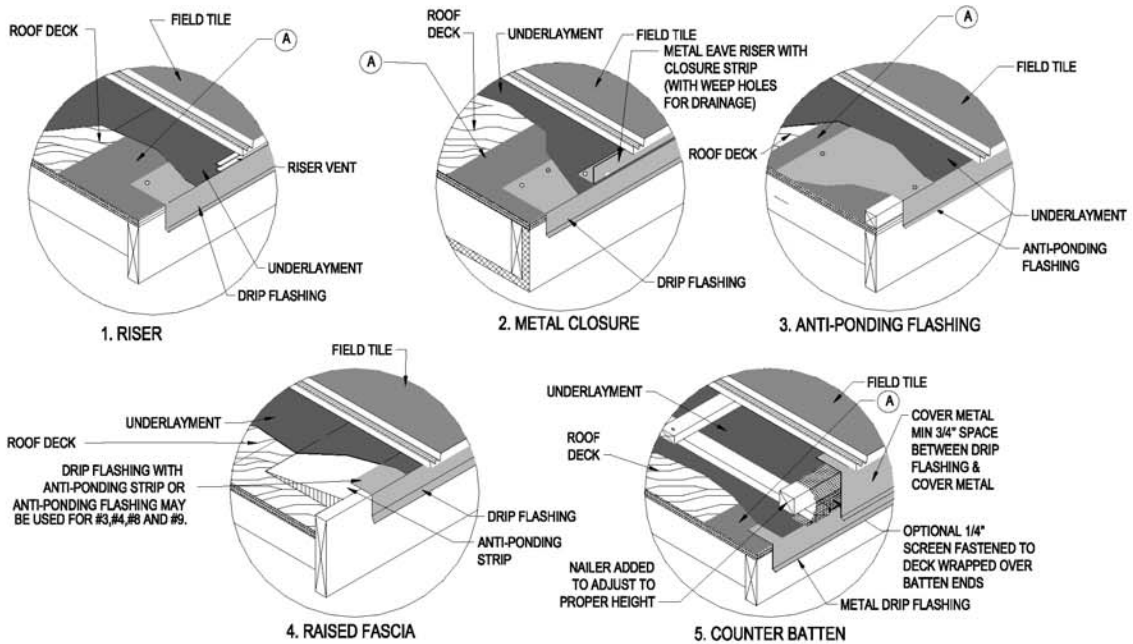

LOW (FLAT) PROFILE TILES

MEDIUM AND HIGH PROFILE TILES

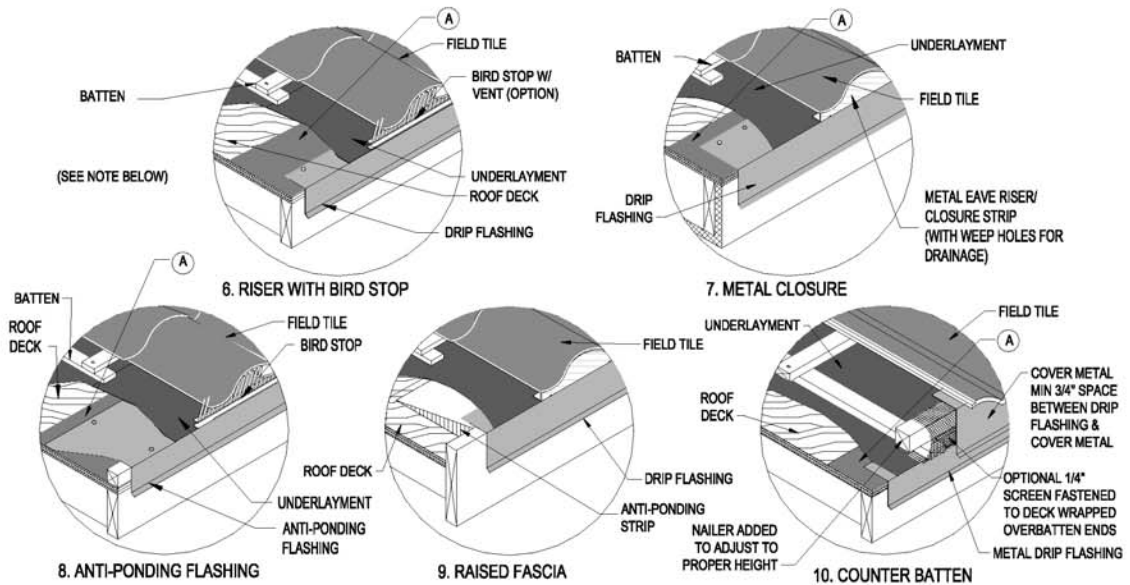

Notes:

1. Bird stop is required on High profile tile and optional on Low and Medium profile tile unless required by local building official.
2. Bird stop may be either solid or vented.
- A. Optional Separator ply or sheet of No.15 asphalt-saturated felt or other appropriate material.

Drawing shown depicts the application of all tile profiles. Unless otherwise noted it would apply to either concrete or clay tiles.

Appendix A

RAISED FASCIA

MC-10A

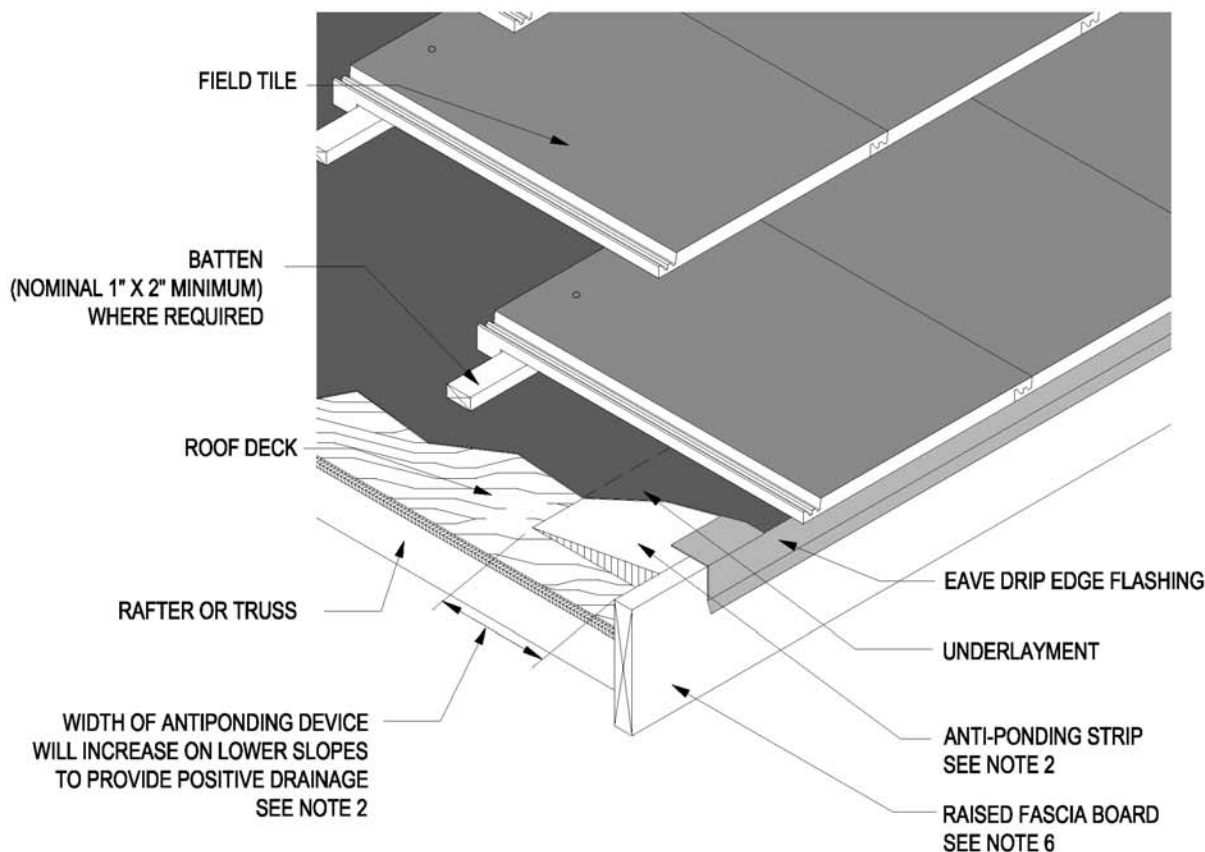

Notes:

1. For recommended underlayment and fastening requirements, see Table 1A and 1B.
2. An anti-ponding device such as a beveled cant strip or shop-formed sheet metal is required at all raised fascia conditions to support the underlayment and provide positive drainage.
3. The tile and/or batten fasteners must penetrate a minimum of 3/4" into dimensional wood decking or pass through wood panel sheathing which ever is less. Once the batten is installed, it becomes part of the "deck" or substrate for tile fastening purposes.
4. Raise fascia board above roof deck to height equal to combined thickness of batten system and thickness of one course of tile.
5. Dimensions shown are minimums and are intended to be approximate to allow for reasonable tolerances due to field conditions.
6. Since raised fascia and starter strips create the same type of water dam situation, they both require an anti-ponding system to allow water to flow off the roof.

Drawing shown depicts the application of all tile profiles. Unless otherwise noted it would apply to either concrete or clay tiles.

EAVE AT FLUSH WALL OR FASCIA / ZERO OVERHANG

MC-10B

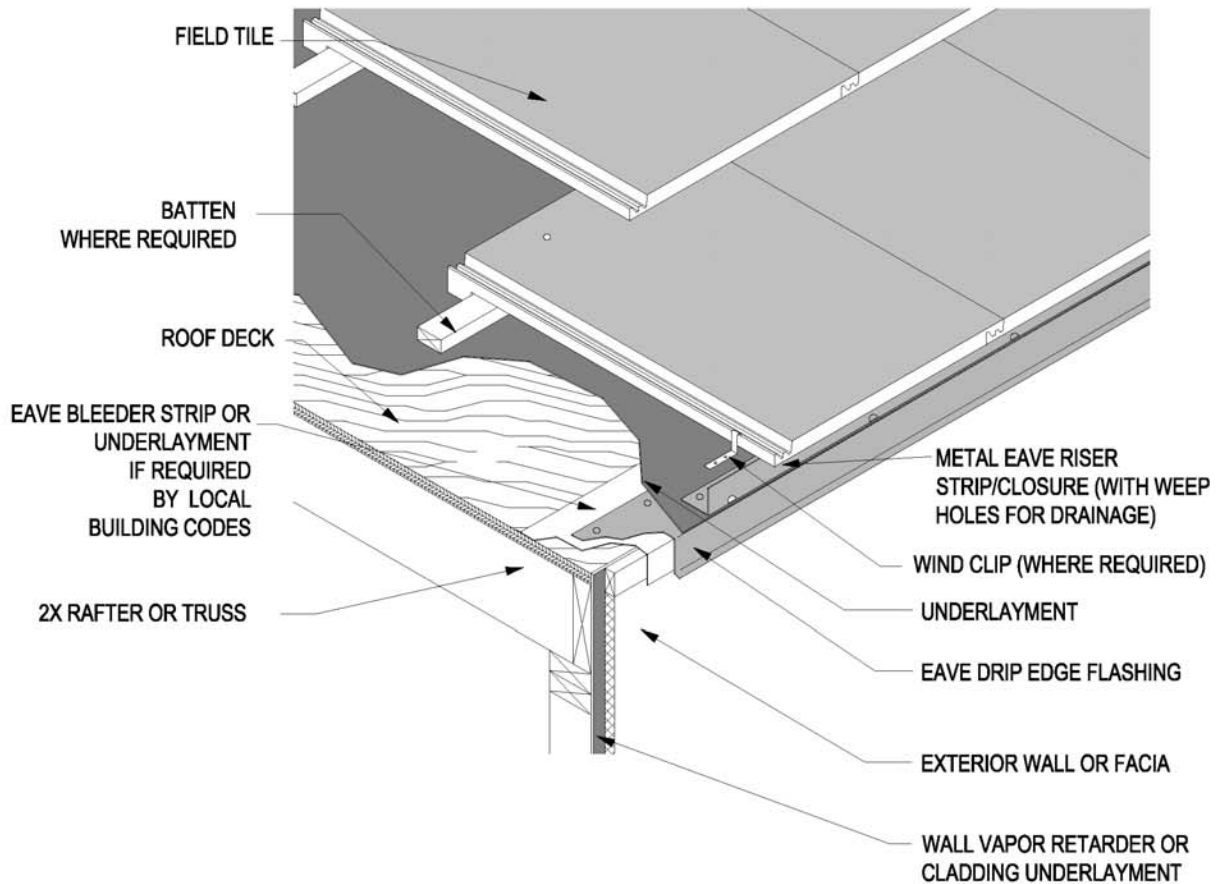

Notes:

1. For recommended underlayment and fastening requirements, see Table 1A and 1B.
2. A eave drip edge flashing is required with: stucco fascia, EIFS (Exterior Insulated Finish System) and flush fascia perimeter edges.
3. Battens for tiles with protruding anchor lugs are optional for slopes between 3:12 and less than or equal to 7:12. Direct deck nailing attachment of tile may be permissible.
4. Eave closure should be of height equal to combined thickness of batten system and thickness of one course of tile.
5. Dimensions shown are minimums and are intended to be approximate to allow for reasonable tolerances due to field conditions.

Drawing shown depicts the application of all tile profiles. Unless otherwise noted it would apply to either concrete or clay tiles.

Appendix A

LOW SLOPE / VENTILATED ROOF EAVE DETAIL

MC-10C

See Table 1A and 1B for underlayment requirements

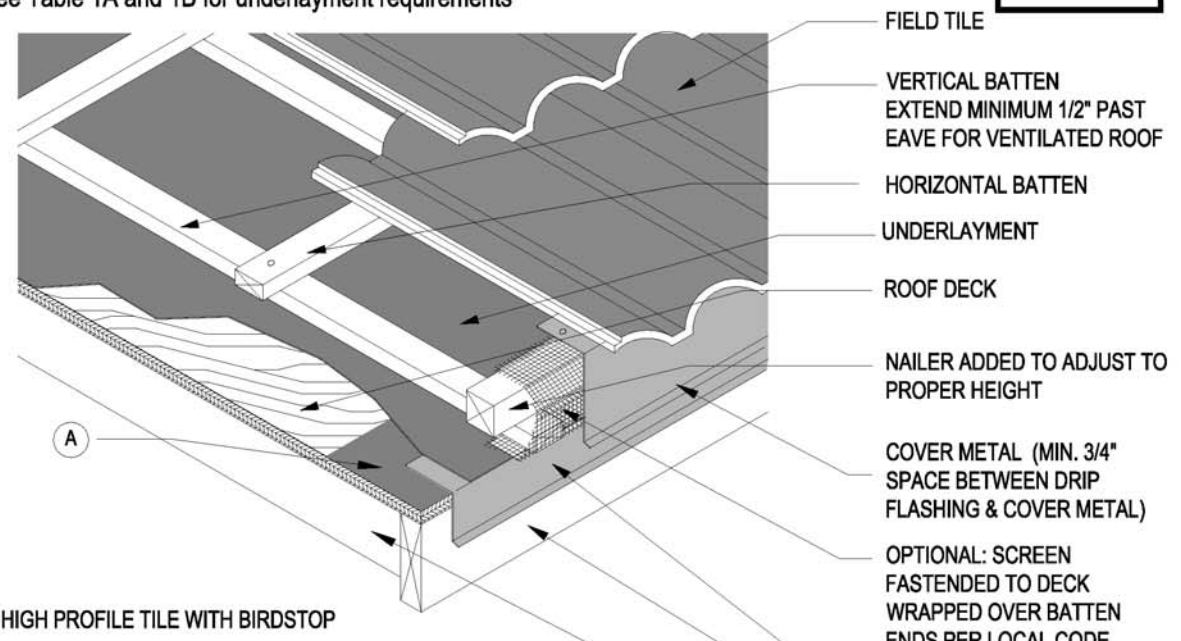

HIGH PROFILE TILE WITH BIRDSTOP

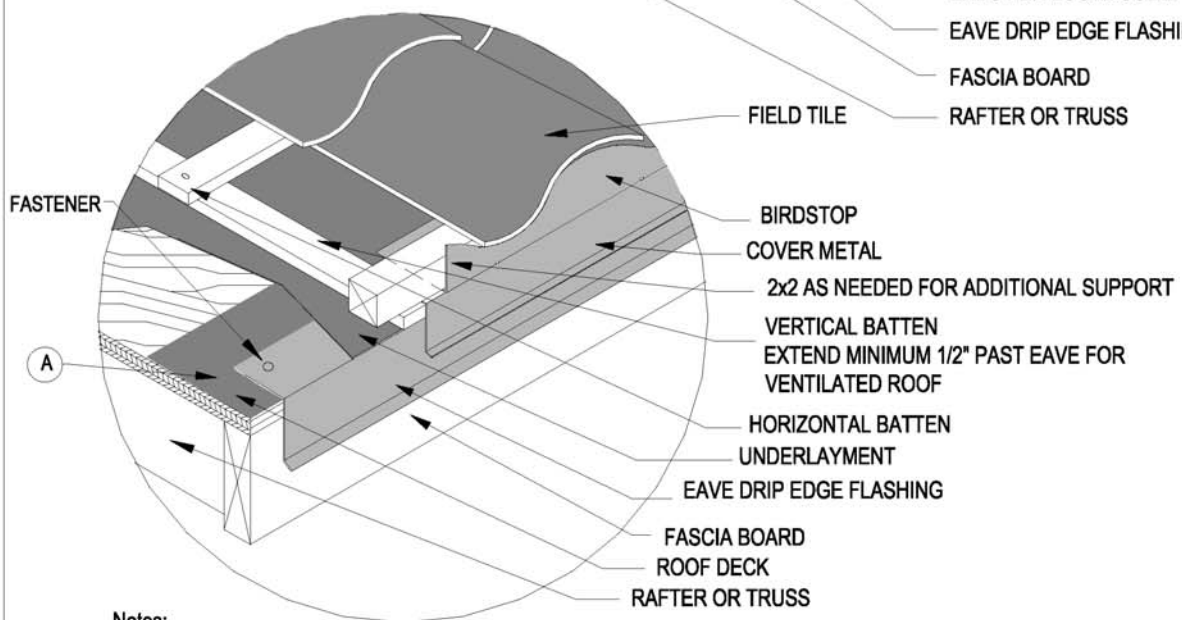

Notes:

1. For recommended underlayment and fastening requirement, see Table 1A and 1B.
 2. A eave drip edge flashing is required at all downslope perimeter edges.
 3. Eave closure shall be of height equal to combined thickness of batten system and thickness of one course of tile. Dimensions shown are minimums and are intended to be approximate to allow for reasonable tolerances due to field conditions.
- A. For extended eave optional separator ply or sheet of No.15 asphalt saturated felt or other appropriate material

Drawing shown depicts the application of all tile profiles. Unless otherwise noted it would apply to either concrete or clay tiles.

DOUBLE LAP TILE (NON-INTERLOCKING)

MC-10D

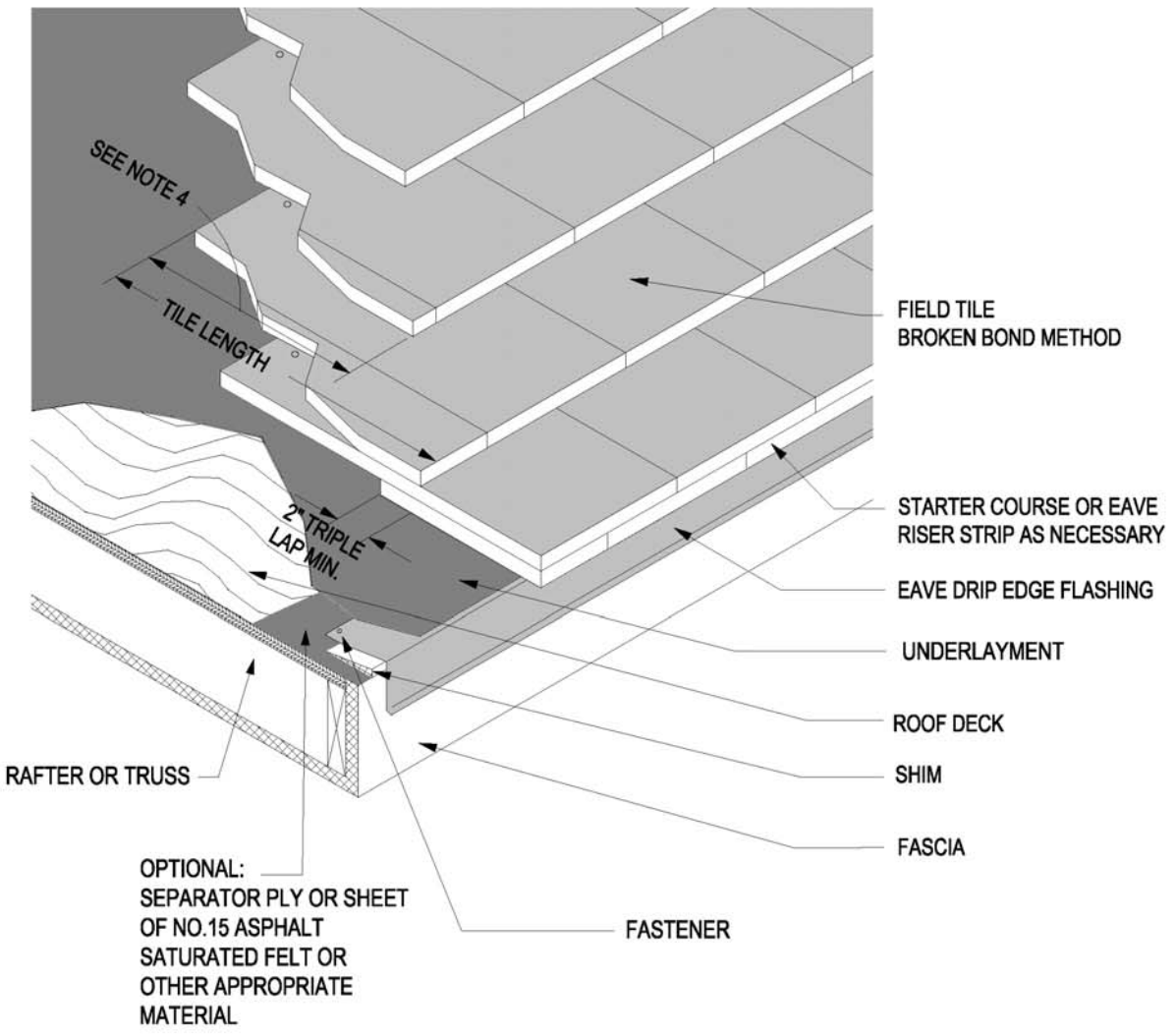

- Notes:
1. For recommended underlayment and fastening requirement, see Table 1A and 1B.
 2. A eave drip edge flashing is required at all down slope perimeter edges.
 3. Dimensions shown are minimums and are intended to be approximate to allow for reasonable tolerances due to field conditions.
 4. Standard head lap equal to tile length minus 2" divided by 2.

Drawing shown depicts the application of all tile profiles. Unless otherwise noted it would apply to either concrete or clay tiles.

Appendix A

HEAD WALL FLASHING

WITH COUNTERFLASHING (Z BAR)

MC-11

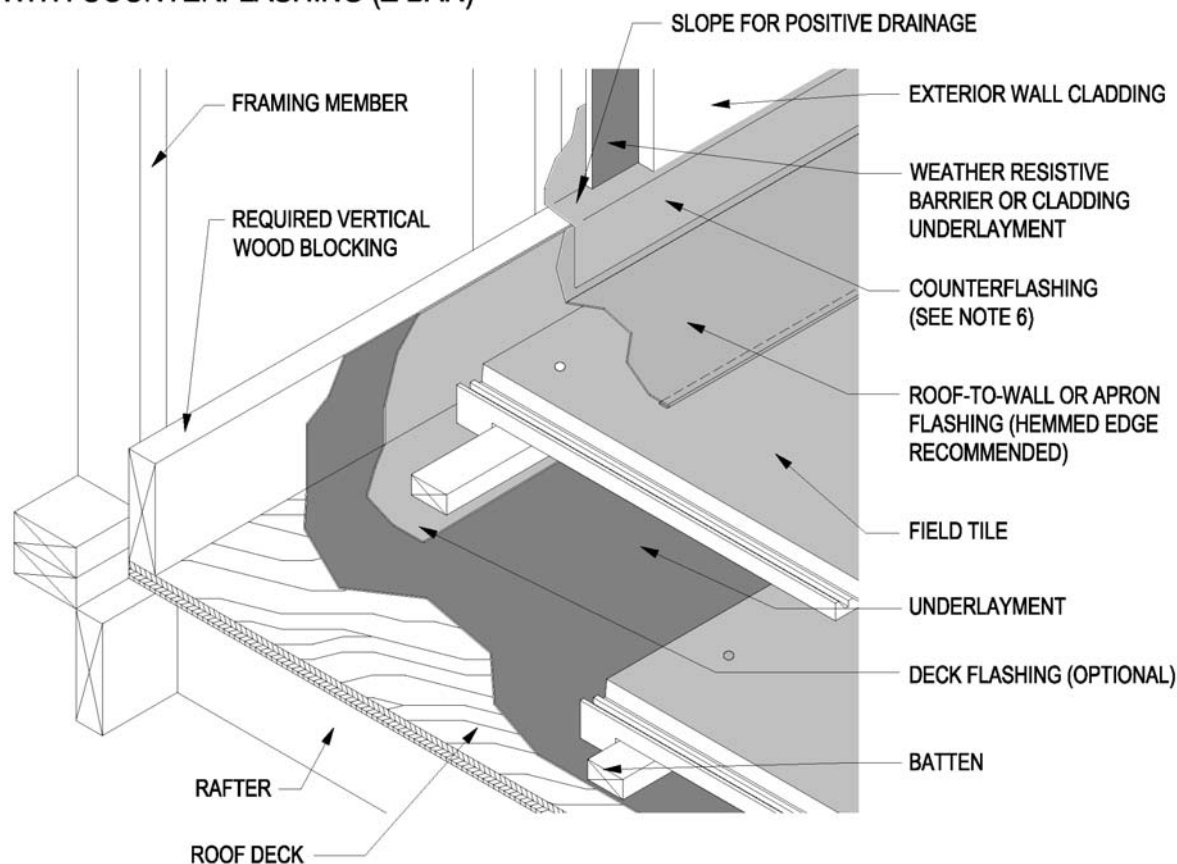

Note:

Openings at hips, ridges and head walls including chimneys, skylights, solar panels, and downslope horizontal abutments shall be fitted with weather blocking material to keep water on the surface of the field tile. Other methods approved by local building official will be allowed. See Technical Bulletin at www.tilerroofing.org

Notes:

1. For recommended underlayment and fastening requirement, see Table 1A and 1B.
2. Underlayment shall extend a minimum of 4" up vertical wood blocking or wall.
3. Apron flashing or other roof-to-wall closure material is necessary at roof-to-wall intersections. Roof-to-wall/apron flashing should extend a minimum of 2" up vertical walls, and provide a minimum of 3" overlap/headlap onto tile. The apron flashing is required to be overlapped a minimum of 2" by sheet metal counterflashing or wall cladding.
4. Solid wood blocking is required behind Z-metal counterflashing applications.
5. Dimensions shown are minimums and are intended to be approximate to allow for reasonable tolerances due to field conditions, and area practices.
6. The bottom edge of the counterflashing height settings shall be set above the roof deck a minimum of 4" for flat tile, 5" for low profile tile, and 6" for high profile tile.
7. All roof flashing shall be a minimum of (No. 26 galvanized sheet gauge) not less than 0.019 inch corrosion-resistant metal (G90). See Table a for additional options.

Drawing shown depicts the application of all tile profiles. Unless otherwise noted it would apply to either concrete or clay tiles.

HEAD WALL FLASHING WITHOUT COUNTERFLASHING

MC-11A

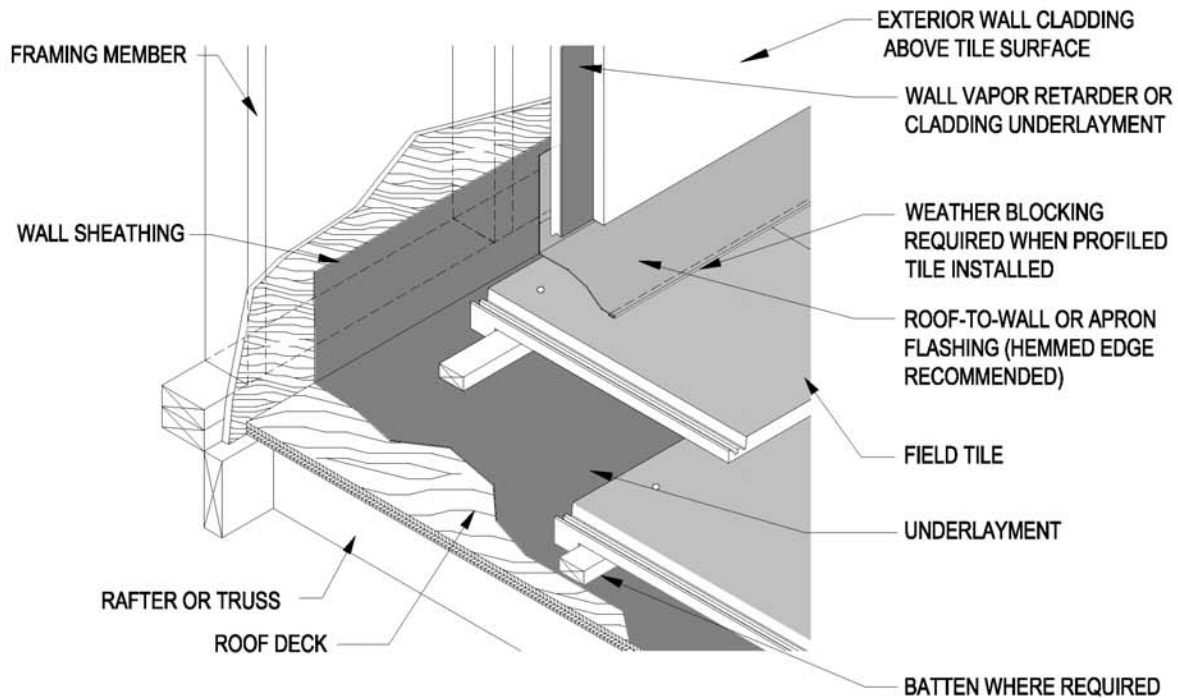

Note:

Openings at hips, ridges and head walls including chimneys, skylights, solar panels, and downslope horizontal abutments shall be fitted with weather blocking material to keep water on the surface of the field tile. Other methods approved by local building official will be allowed. See Technical Bulletin at www.tilerroofing.org

Notes:

1. For recommended underlayment and fastening requirement, see Table 1A and 1B.
2. Underlayment shall extend a minimum of 4" up vertical wood blocking or wall, and is suggested to extend above wall flashing.
3. Apron flashing or other roof-to-wall closure material is necessary at roof-to-wall intersections. Roof-to-wall/apron flashing should extend a minimum of 2", with 4" preferred up vertical walls, and provide a minimum of 3" overlap/headlap onto tile. The apron flashing is required to be overlapped a minimum of 2" by sheet metal counterflashing or wall cladding.
4. Dimensions shown are minimum and are intended to be approximate to allow for reasonable tolerances due to field conditions.
5. The bottom edge of the counterflashing height settings shall be set above the roof deck a minimum of 4" for flat tile, 5" for low profile tile, and 6" for high profile tile.
6. All roof flashing shall be a minimum of (No. 26 galvanized sheet gaUge) not less than 0.019 inch corrosion-resistant metal (G90). See Table A for additional options.

Drawing shown depicts the application of all tile profiles. Unless otherwise noted it would apply to either concrete or clay tiles.

Appendix A

PAN FLASHING AT ROOF-TO-SIDEWALL

Where Wall Extends Past Eave With Counterflashing (Z-Bar)

MC-12

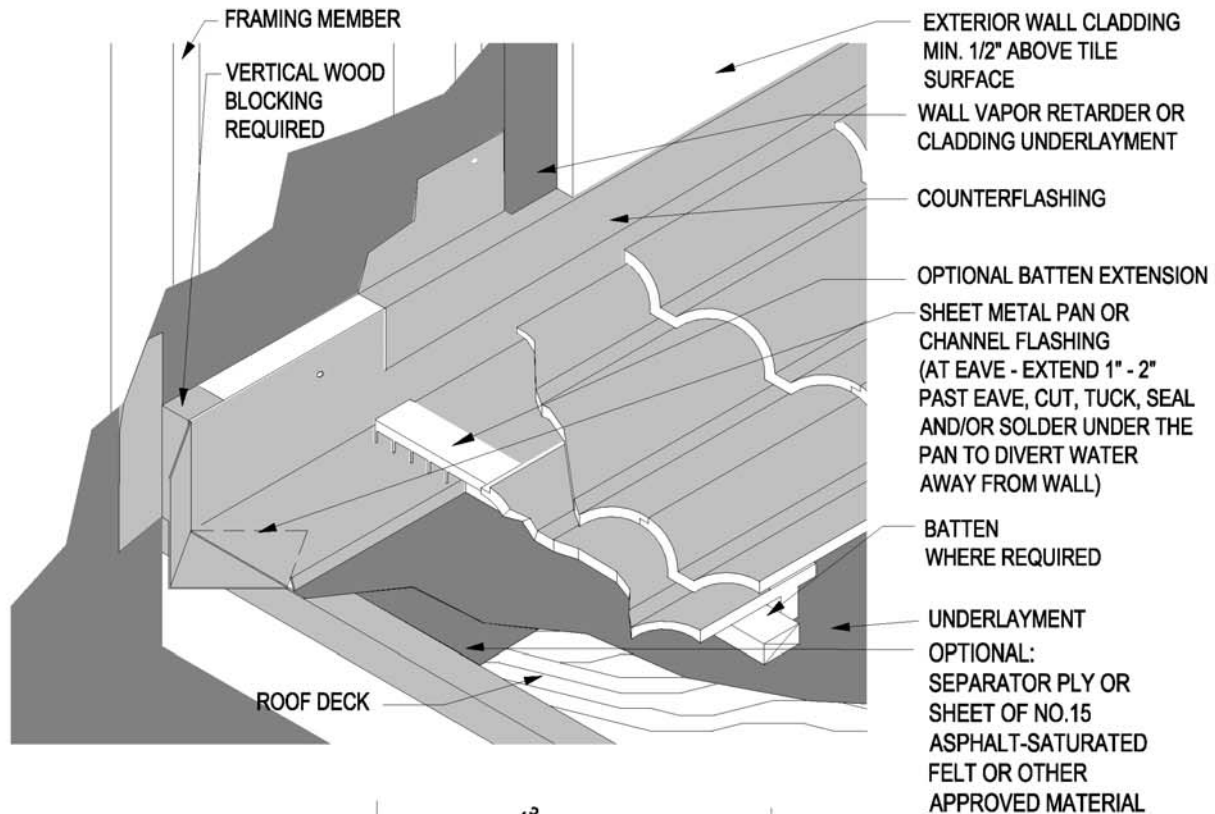

Notes:

1. For recommended underlayment and fastening requirement, see Table 1A and 1B.
2. Underlayment shall extend a minimum of 4" up vertical wood blocking or wall.
3. Sheet metal pan flashing shall extend a minimum of 4" up the vertical wall approximately 6" out over the deck and have a minimum 3/4" return upward.
4. Solid wood blocking is required behind pan flashing and Z-metal counterflashing. Z metal or other counter flashing shall overlap vertical flange of pan or channel flashing by approximately 2" or greater.
5. At terminating tile, cut head lugs where they would otherwise create a damming condition or drainage impairment. Use a roof tile adhesive approved by the local building officials or use wire ties or batten extender to secure tile.
6. Dimensions shown are minimums and are intended to be approximate to allow for reasonable tolerances due to field conditions.
7. Consideration shall be given to tributary area of roof for pan flashing design.
8. All roof flashing shall be a minimum of (No. 26 galvanized sheet gauge) not less than 0.019 inch corrosion-resistant metal (G90). See Table A for additional options.

Drawing shown depicts the application of all tile profiles. Unless otherwise noted it would apply to either concrete or clay tiles.

PAN FLASHING AT ROOF-TO-SIDEWALL

Where Wall Extends Past Eave

MC-12A

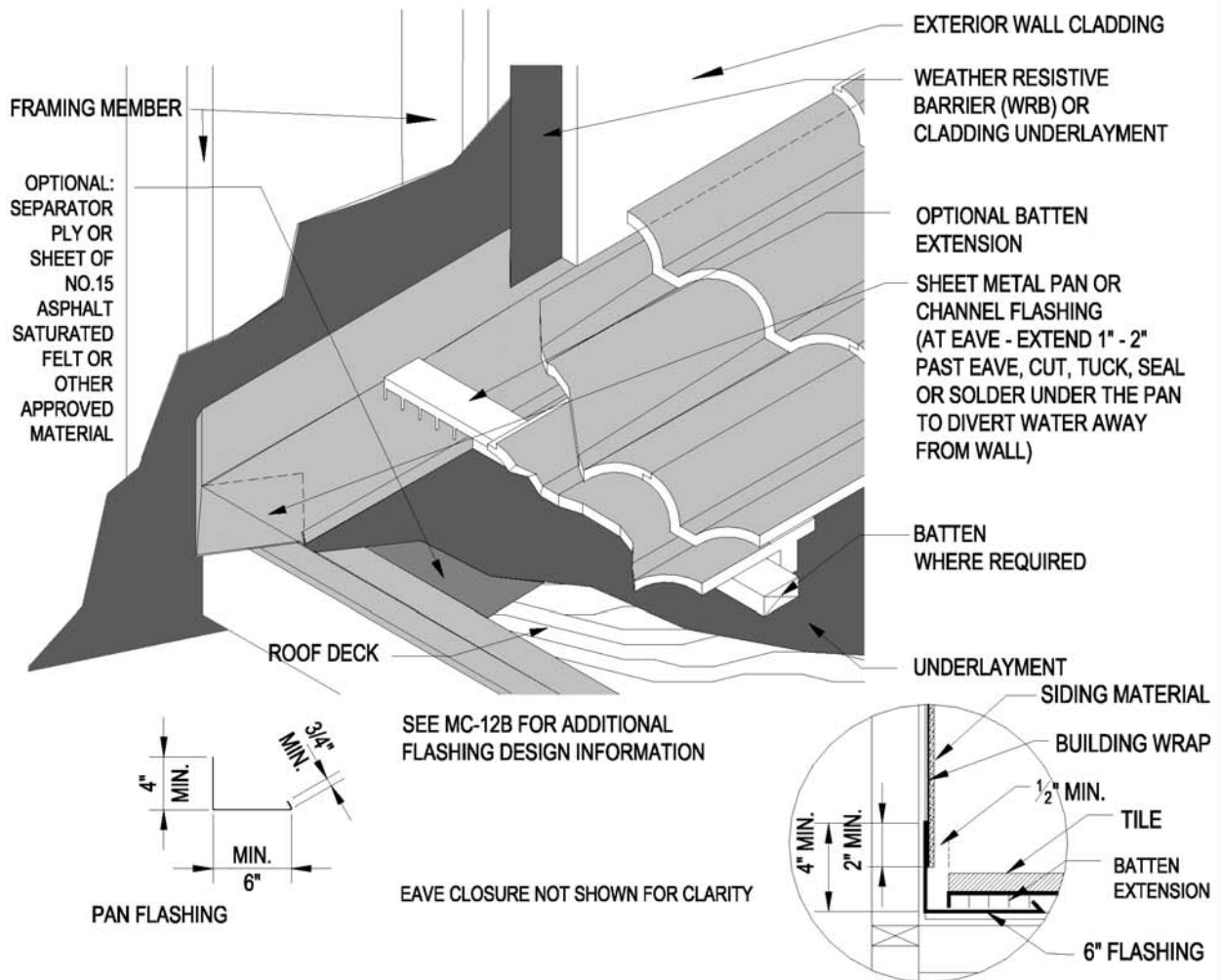

Notes:

1. For recommended underlayment and fastening requirement, see Table 1A and 1B.
2. Underlayment shall extend a minimum of 4" up vertical wood blocking or wall.
3. Sheet metal pan flashing shall extend a minimum of 4" up the vertical wall approximately 6" out over the deck and have a minimum 3/4" return upward.
4. At terminating tile, cut head lugs where they would otherwise create a daming conditon or drainage impairment. Use a roof tile adhesive approved by the local building officials or use wire ties or batten extender to secure tile.
5. Dimensions shown are minimums and are intended to be approximate to allow for reasonable tolerances due to field conditions.
6. Consideration shall be given to tributary area of roof for pan flashing design.
7. All roof flashing shall be a minimum of (No. 26 galvanized sheet gauge) not less than 0.019 inch corrosion-resistant metal (G90). See Table A for additional options.

Drawing shown depicts the application of all tile profiles. Unless otherwise noted it would apply to either concrete or clay tiles.

Appendix A

METAL FLASHING EXAMPLES

See MC-19A for additional rake flashing examples

MC-12B

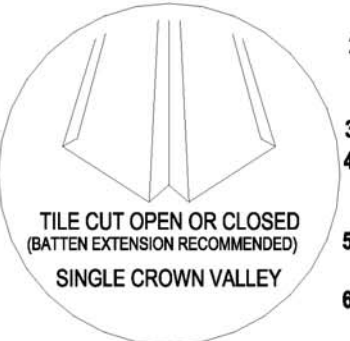
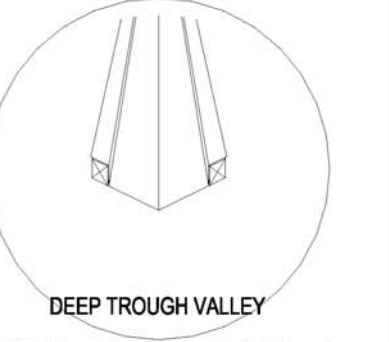
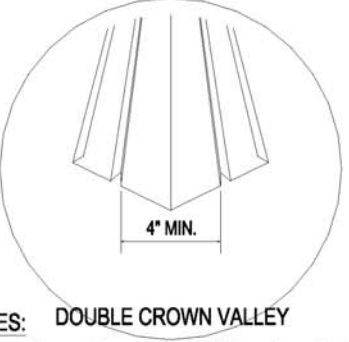
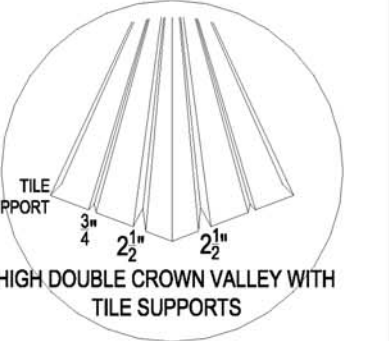
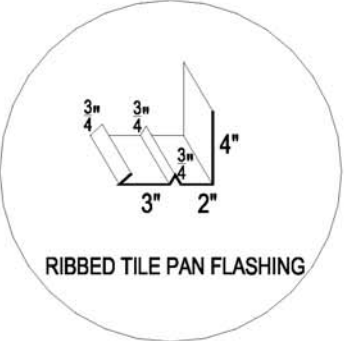
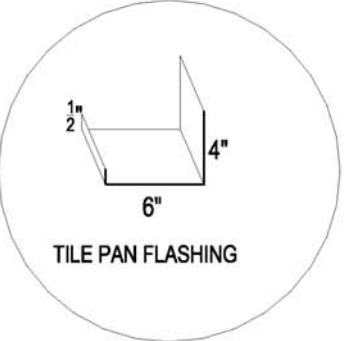
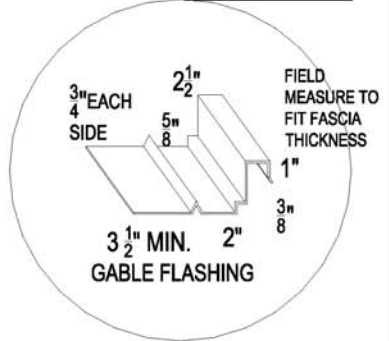
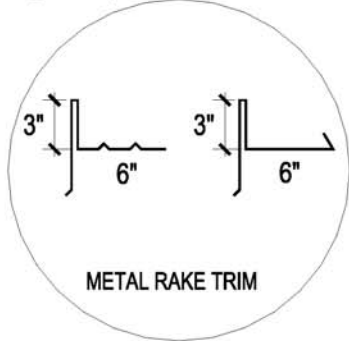
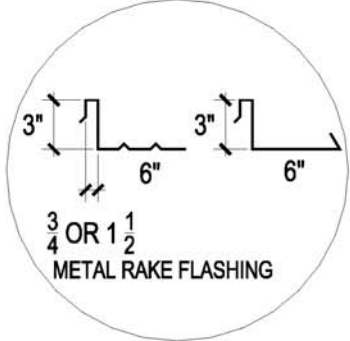

- NOTES:
1. These pictures show options that are found in the field at this time; other designs that will handle anticipated water flows may be used upon submissions of supporting data indicating that anticipated water flows are equivalent to the code requirements.
 2. Valley metals shall extend 11" each way in compliance with International Building Code (IBC) section 1507.3.9, International Residential Code (IRC) R905.3.8 and Uniform Building Code (UBC) section 1508.4 unless approved by the local building official.
 3. Tile valleys may be cut, closed, or open.
 4. When flat profiled tile is installed as "Closed Valley" a ribbed valley metal or a single crown valley metal with a batten extension shall be used. Valley metals shall conform to IBC section 1507.3.9, IRC R905.3.8 and UBC section 1508.4.
 5. Dimensions shown are minimums and are intended to be approximate to allow for reasonable tolerances due to field conditions, and area practices.
 6. All roof flashing shall be minimum of (No. 26 galvanized sheet gauge) not less than 0.019 inch corrosion-resistant metal (G90). See Table A for additional options.

Drawing shown depicts the application of all tile profiles. Unless otherwise noted it would apply to either concrete or clay tiles.

SIDEWALL DETAILS - CLAY 'S' TILE

MC-13

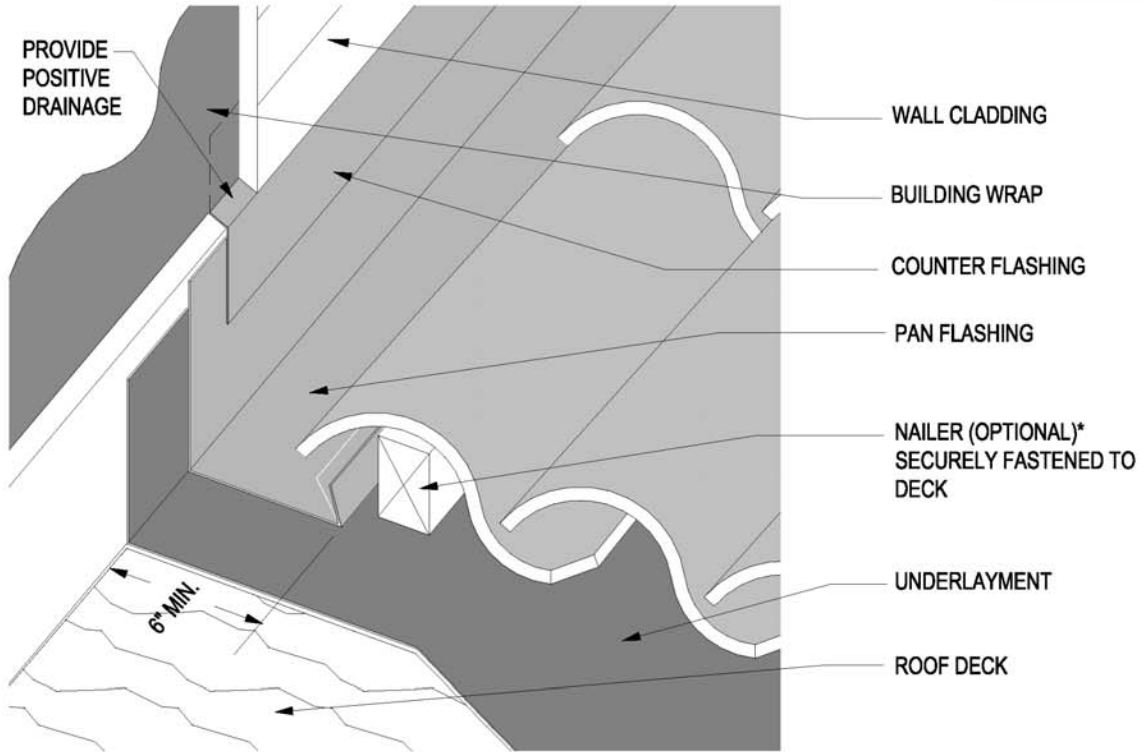

*Note: Tiles to be installed in such a fashion as to prevent water diversion or blockage. For recommended underlayment and fastening requirement, see Table 1A and 1B.

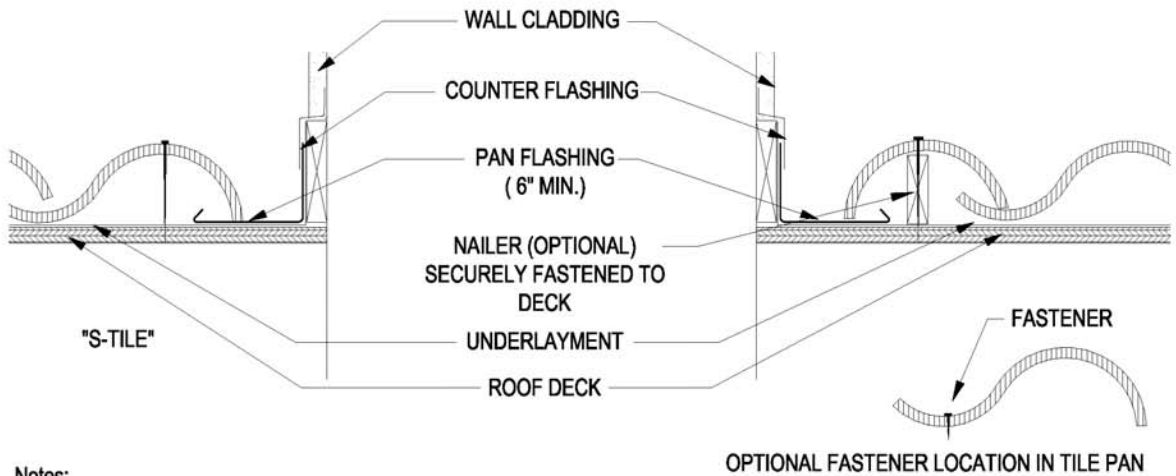

Notes:

1. Underlayment should extend a minimum of 4" up vertical wood blocking or wall.
2. See MC-12B for additional flashing details.

Drawing shown depicts the application of all tile profiles. Unless otherwise noted it would apply to either concrete or clay tiles.

Appendix A

SIDEWALL DETAILS - TWO PIECE CLAY

MC-13A

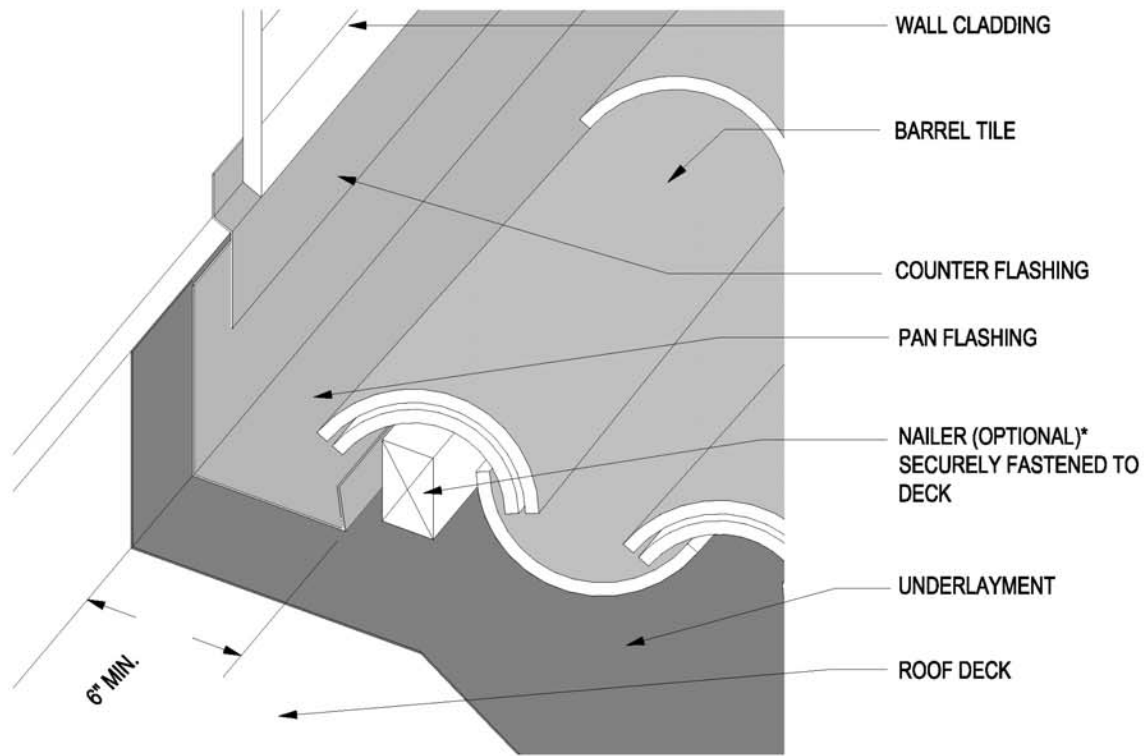

*Note: Tiles to be installed in such a fashion as to prevent water diversion of blockage. Fasteners shall be of sufficient length to penetrate $\frac{3}{4}$ " into, or through the roof sheathing, which ever is less. See Table 1A and 1B for more information.

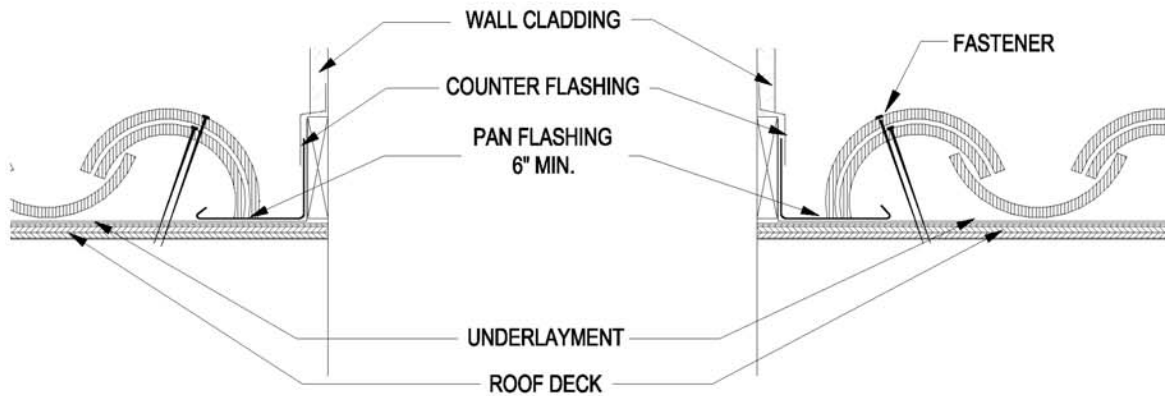

- Notes:
1. Underlayment should extend a minimum of 4" up vertical wood blocking or wall.
 2. See MC-12B for additional flashing details.

Drawing shown depicts the application of all tile profiles. Unless otherwise noted it would apply to either concrete or clay tiles.

CHIMNEY FLASHING - PAN TYPE (Chimney or other penetration 30" or less in width)

MC-14

NOTE:
WHERE DEBRIS CAN ACCUMULATE, SEE STEP FLASHING OPTION "MC-14A"

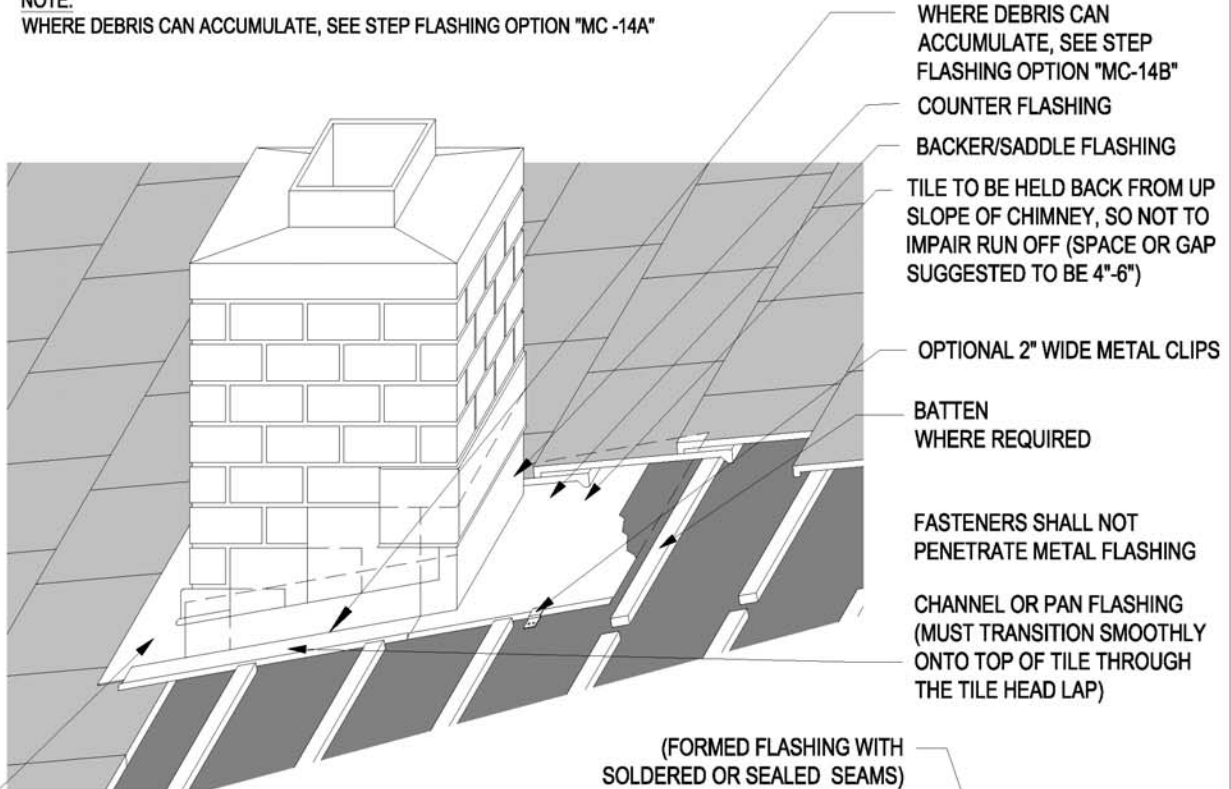

APRON FLASHING WITH WEATHER BLOCKING FOR LOW AND HIGH PROFILE TILES

APRON TO BE OF SUFFICIENT LENGTH TO PROVIDE MIN. 3" LAP ONTO TILE.

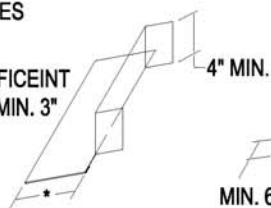

APRON FLASHING

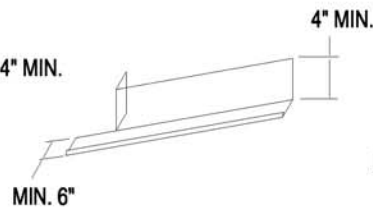

PAN OR CHANNEL FLASHING

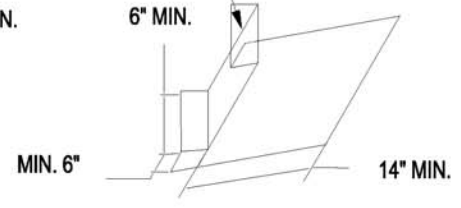

BACKER OR SADDLE FLASHING

Notes:

1. Chimney flashing dimensions may vary according to local weather conditions, chimney size, chimney location, slope of roof, rafter length behind chimney and tributary water area.
2. A backer or saddle flashing may be used for chimneys and other penetrations 30" or less in width. Extend a minimum of 6" up chimney.
3. A diverter or cricket flashing is recommended for chimneys and other penetrations equal to or greater than 30" in width to promote positive runoff.
4. Dimensions shown are recommended minimums and are intended to be approximate to allow for reasonable tolerances due to field conditions, and area practices.
5. Flashing must be securely fastened to chimney or sidewall framing.
6. Underlayment must turn up chimney wall a minimum of 4 inches.
7. All chimney flashing shall be minimum of (No. 26 galvanized sheet gauge) not less than 0.019 inch corrosion-resistant metal (G90). See Table A for additional options.

Drawing shown depicts the application of all tile profiles. Unless otherwise noted it would apply to either concrete or clay tiles.

Appendix A

CHIMNEY FLASHING - STEP TYPE (Chimney or other penetration 30" or less in width)

MC-14A

NOTE:
TYPICALLY USED IN AREAS WHERE DEBRIS CAN ACCUMULATE

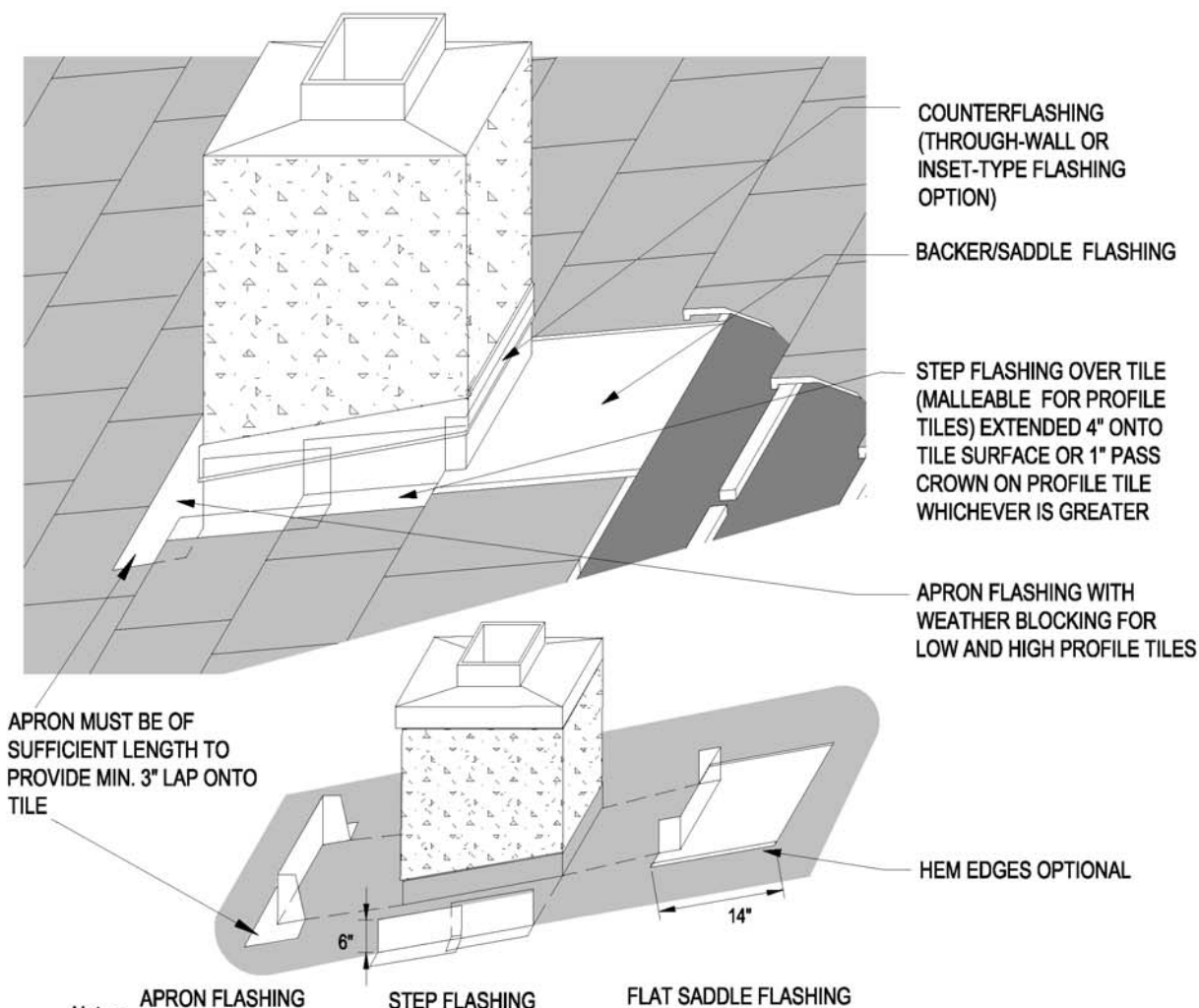

Notes:

1. Chimney flashing dimensions may vary according to local weather conditions, chimney size, chimney location, slope of roof, rafter length behind chimney and tributary water area.
2. A backer or saddle flashing may be used for chimneys and other penetrations less than 30" in width. Extend a minimum of 6" up chimney, and 14" minimum upslope of chimney.
3. A diverter or cricket flashing is recommended for chimneys and other penetrations greater than 30" in width to promote positive runoff.
4. Dimensions shown are recommended minimums and are intended to be approximate to allow for reasonable tolerances due to field conditions, and area practices.
5. Underlayment must turn up chimney wall a minimum of 4 inches.
6. All chimney flashing shall be minimum of (No. 26 galvanized sheet gauge) not less than 0.019 inch corrosion-resistant metal (G90). See Table A for additional options.

Drawing shown depicts the application of all tile profiles. Unless otherwise noted it would apply to either concrete or clay tiles.

CHIMNEY CRICKET FLASHING - PAN TYPE (Chimney or other penetration greater than 30" wide)

MC-15

NOTE:
WHERE DEBRIS CAN ACCUMULATE, SEE STEP FLASHING OPTION "MC-15A"

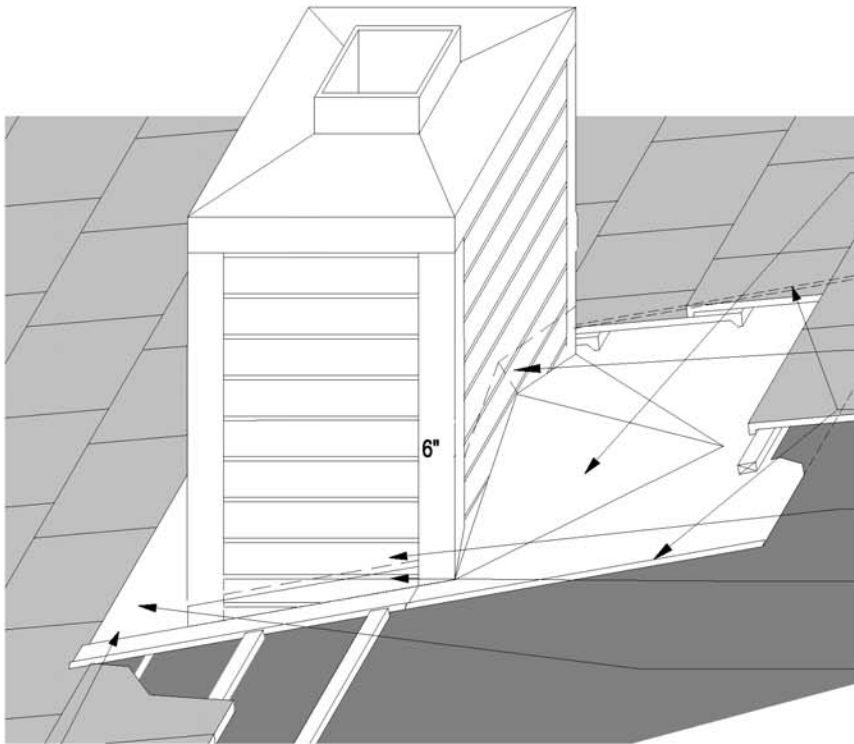

CRICKET MAY BE COVERED WITH AN APPROVED SEALED SYSTEM IN ACCORDANCE WITH LOW-SLOPE ROOFING REQUIREMENTS

CRICKET FLASHING (EXTEND UPPER END OF FLASHING 6" MIN. BEYOND FIRST COURSE OF OVERLAYING TILE)

MIN. 2" ABOVE APEX

CRICKET METAL FLASHING WITH OPTIONAL HEM

COUNTERFLASHING

CHANNEL OR PAN FLASHING

APRON FLASHING WITH WEATHER BLOCKING FOR LOW AND HIGH PROFILE TILES

APRON MUST BE OF SUFFICIENT LENGTH TO PROVIDE 3" LAP ONTO TILE

(FORM FLASHING WITH SOLDERED OR SEALED SEAMS)

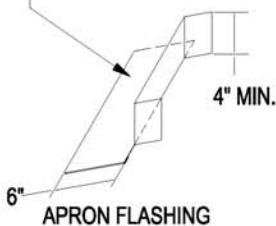

APRON FLASHING

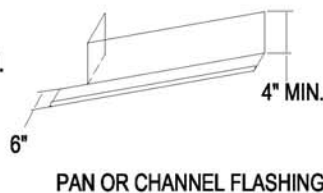

PAN OR CHANNEL FLASHING

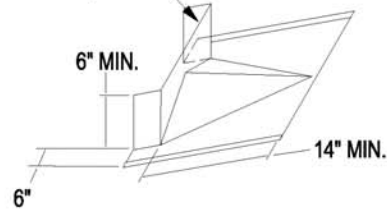

CRICKET FLASHING

Notes:

1. Chimney flashing dimensions may vary according to local weather conditions, chimney size, chimney location, slope of roof, rafter length behind chimney and tributary water area.
2. A backer or saddle flashing may be used for chimneys and other penetrations less than 30" in width.
3. Extend a minimum of 6" up chimney and 14" up roof slope.
4. A diverter or cricket flashing is recommended for chimneys and other penetration greater than 30" in width to promote positive runoff.
5. Dimensions shown are recommended minimums and are intended to be approximate to allow for reasonable tolerances due to field conditions, and area practices.
6. Underlayment must turn up chimney wall a minimum of 4 inches.
7. All chimney flashing shall be minimum of (No. 26 galvanized sheet gauge) not less than 0.019 inch corrosion-resistant metal (G90). See Table A for additional options.

Drawing shown depicts the application of all tile profiles. Unless otherwise noted it would apply to either concrete or clay tiles.

CHIMNEY CRICKET FLASHING - STEP TYPE (Chimney or other penetration greater than 30" wide)

MC-15A

NOTE:
TYPICALLY USED IN AREAS WHERE DEBRIS CAN ACCUMULATE

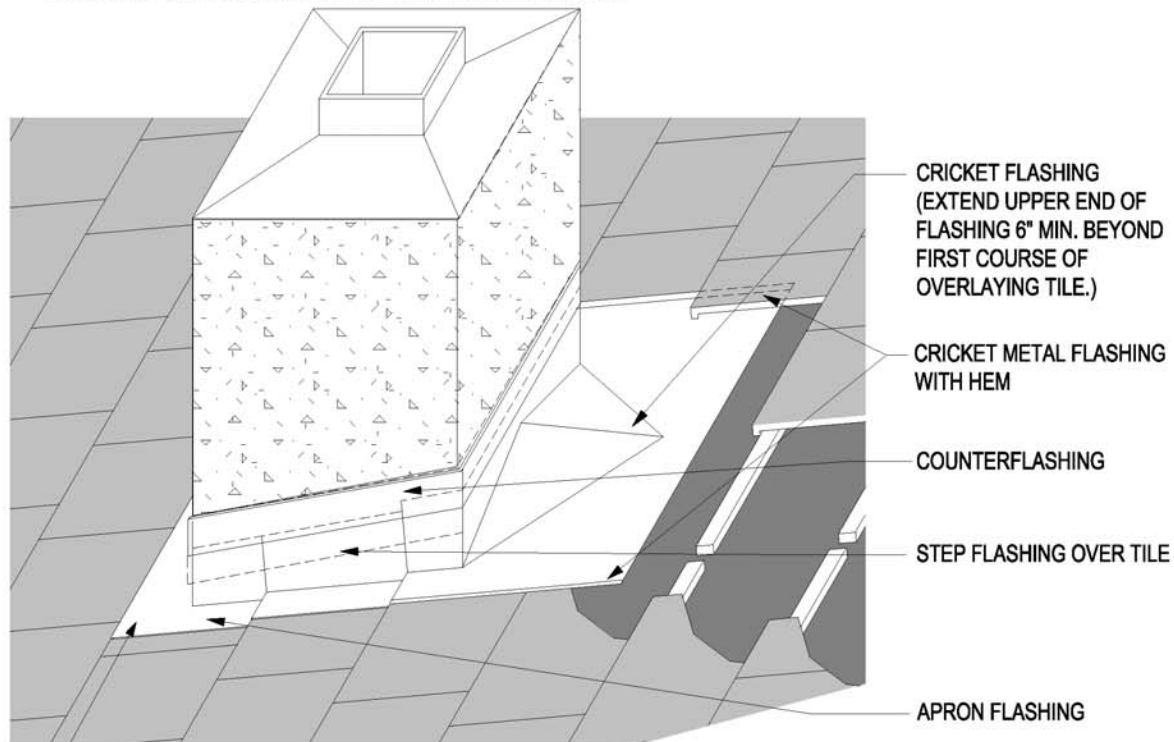

APRON TO BE SUFFICIENT
LENGTH TO EXTEND 3" ONTO
TILE

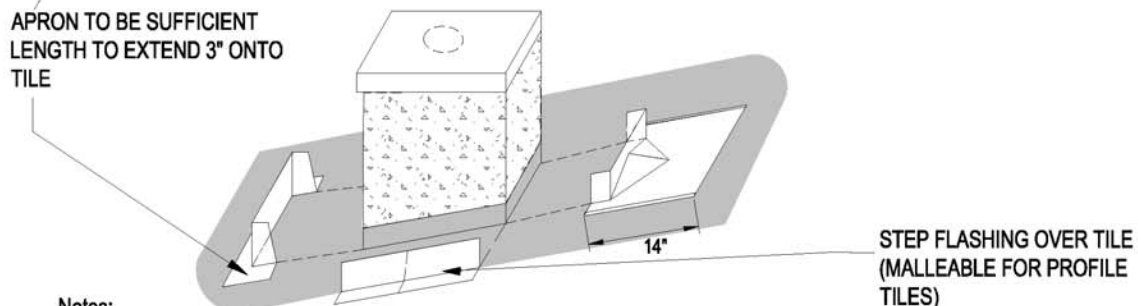

Notes:

1. Chimney flashing dimensions may vary according to local weather conditions, chimney size, chimney location, slope of roof, rafter length behind chimney and tributary water area.
2. A backer or flashing may be used for chimneys and other penetrations less than 30" in width.
3. Extend a minimum of 6" up chimney and 14" upslope.
4. A diverter or cricket flashing is recommended for chimneys and other penetrations greater than 30" in width to promote positive runoff.
5. Dimensions shown are recommended minimums and are intended to be approximate to allow for reasonable tolerances due to field conditions.
6. Underlayment must turn up chimney wall a minimum of 4 inches.
7. All chimney flashing shall be minimum of (No. 26 galvanized sheet gauge) not less than 0.019 inch corrosion-resistant metal (G90). See Table A for additional options.

Drawing shown depicts the application of all tile profiles. Unless otherwise noted it would apply to either concrete or clay tiles.

SKYLIGHT UNDERLAYMENT DETAIL

MC-16

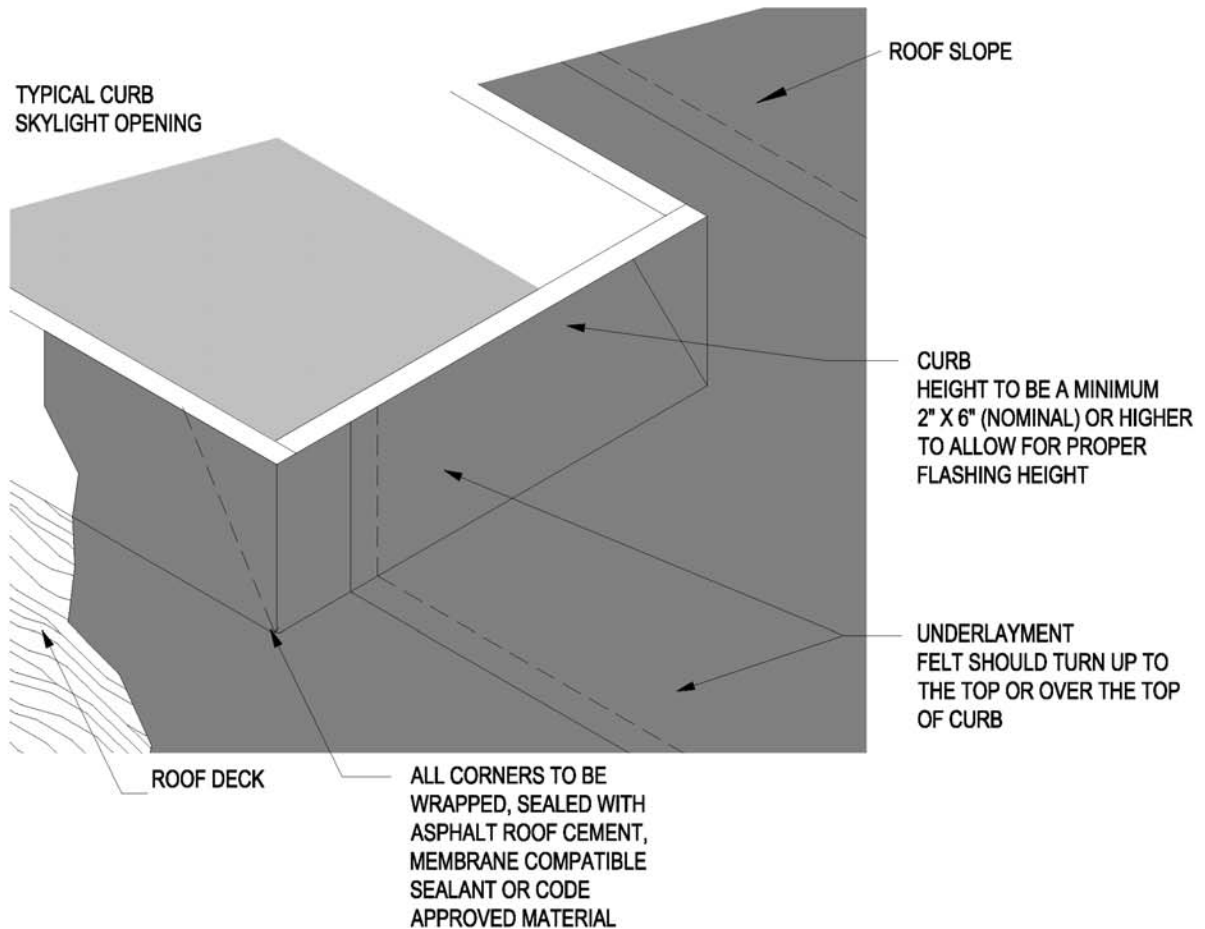

Notes:

1. For recommended underlayment and fastening requirement, see Table 1A and 1B.
2. Dimensions shown are minimums and are intended to be approximate to allow for reasonable tolerances due to field conditions, and area practices.
3. A backer or saddle flashing should be used for curbed penetrations, depending upon width or curb. Extend flashing a minimum of 6" up curb.

Drawing shown depicts the application of all tile profiles. Unless otherwise noted it would apply to either concrete or clay tiles.

Appendix A

SKYLIGHT FLASHING - PAN TYPE

MC-16A

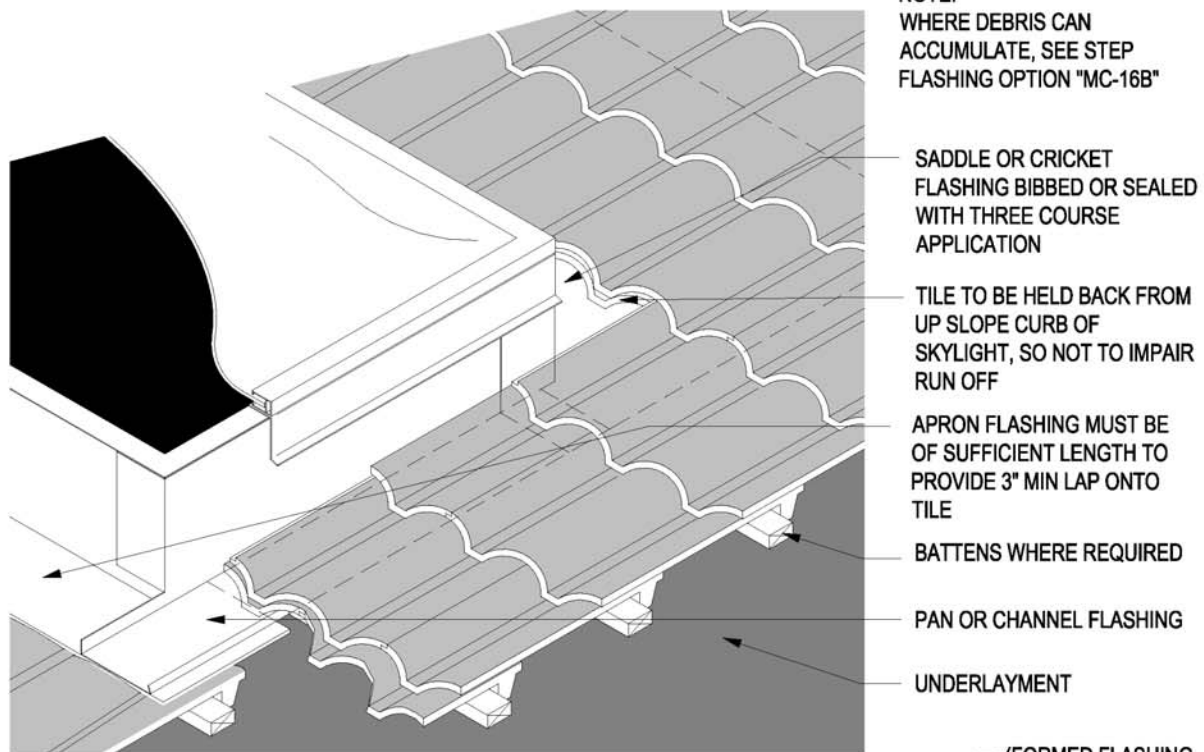

NOTE:
WHERE DEBRIS CAN
ACCUMULATE, SEE STEP
FLASHING OPTION "MC-16B"

SADDLE OR CRICKET
FLASHING BIBBED OR SEALED
WITH THREE COURSE
APPLICATION

TILE TO BE HELD BACK FROM
UP SLOPE CURB OF
SKYLIGHT, SO NOT TO IMPAIR
RUN OFF

APRON FLASHING MUST BE
OF SUFFICIENT LENGTH TO
PROVIDE 3" MIN LAP ONTO
TILE

BATTENS WHERE REQUIRED

PAN OR CHANNEL FLASHING

UNDERLAYMENT

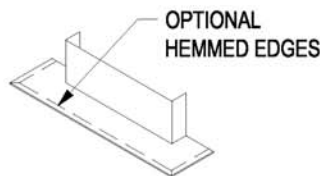

APRON FLASHING

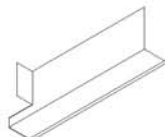

PAN OR CHANNEL FLASHING

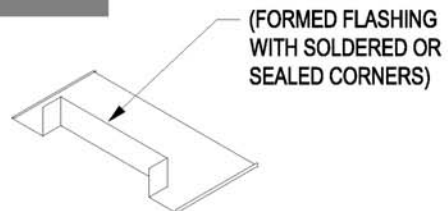

SADDLE/BACKER FLASHING

Notes:

1. Skylight flashing dimensions may vary according to local weather conditions, curb size, location, slope of roof, rafter length behind skylight and contributory run off area.
2. A backer or saddle flashing may be used for skylights and other penetrations less than 30" in width. Extend a minimum of 6" up or to top of curb, and 14" up roof slope.
3. A cricket flashing is recommended for skylights and penetrations equal to or greater than 30" in width to promote positive runoff, unless supporting data shows otherwise.
4. For recommended underlayment and fastening requirement, see Table 1A and 1B.
5. Dimensions shown are minimums and are intended to be approximate to allow for reasonable tolerances due to field conditions.
6. Malleable metal or weather blocking material, required for weather closure with profiled tile.
7. All skylight flashing shall be minimum of (No. 26 galvanized sheet gauge) not less than 0.019 inch corrosion-resistant metal (G90). See Table A for additional options.

Drawing shown depicts the application of all tile profiles. Unless otherwise noted it would apply to either concrete or clay tiles.

SKYLIGHT STEP FLASHING

MC-16B

NOTE:
TYPICALLY USED IN AREAS WHERE DEBRIS CAN ACCUMULATE

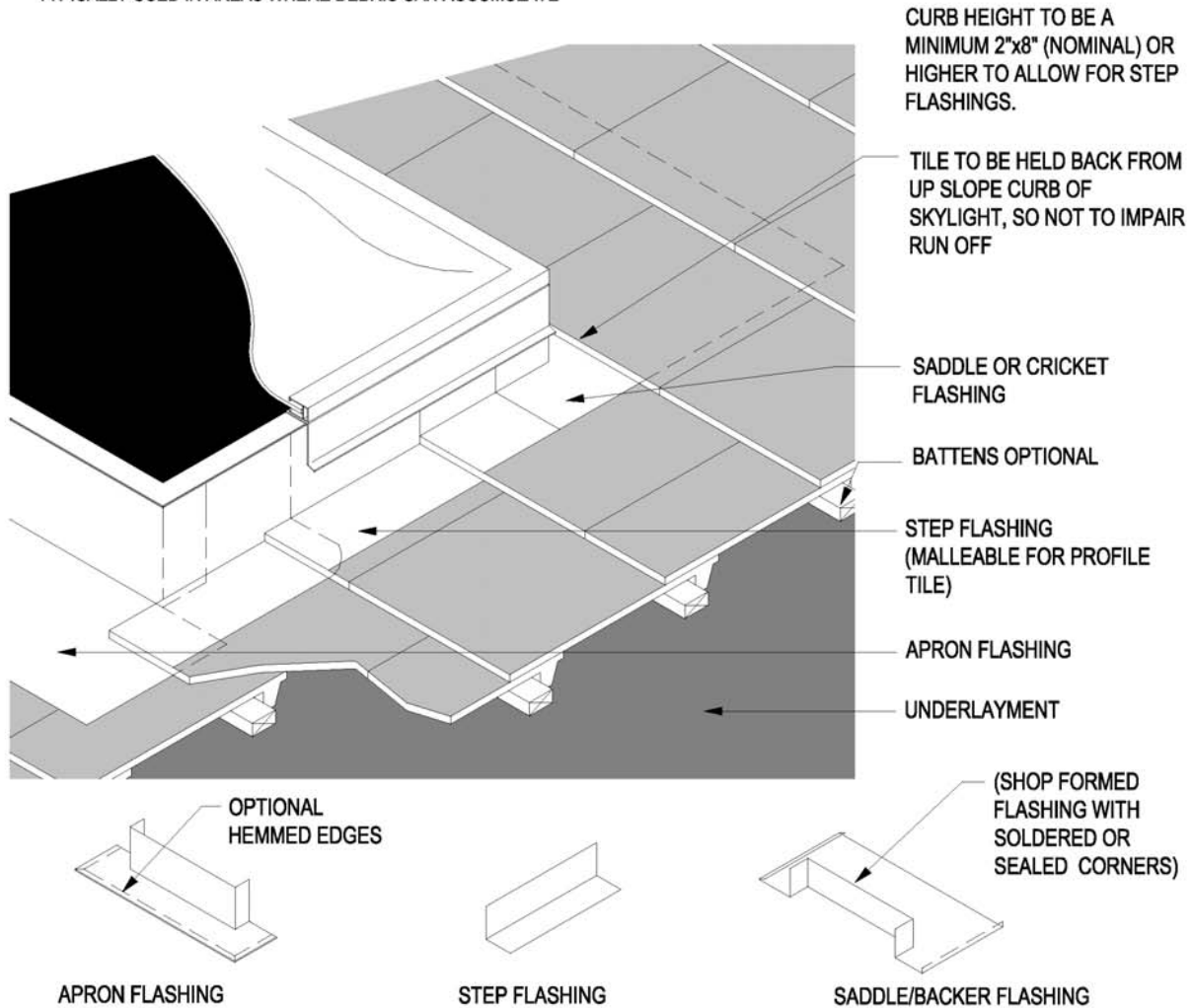

CURB HEIGHT TO BE A MINIMUM 2"x8" (NOMINAL) OR HIGHER TO ALLOW FOR STEP FLASHINGS.

TILE TO BE HELD BACK FROM UP SLOPE CURB OF SKYLIGHT, SO NOT TO IMPAIR RUN OFF

SADDLE OR CRICKET FLASHING

BATTENS OPTIONAL

STEP FLASHING (MALLEABLE FOR PROFILE TILE)

APRON FLASHING

UNDERLAYMENT

OPTIONAL HEMMED EDGES

(SHOP FORMED FLASHING WITH SOLDERED OR SEALED CORNERS)

APRON FLASHING

STEP FLASHING

SADDLE/BACKER FLASHING

Notes:

1. Skylight flashing dimensions will vary according to local weather conditions, size, location, slope of roof, rafter length behind skylight and contributory run off area.
2. A backer or saddle flashing may be used for skylights and other penetrations less than 30" in width. Extend a minimum of 6" up or to top of curb and 14" up roof slope.
3. A cricket flashing is recommended for skylights and penetrations equal to or greater than 30" in width to promote positive runoff.
4. For recommended underlayment and fastening requirement, see Table 1A and 1B.
5. Dimensions shown are minimums and are intended to be approximate to allow for reasonable tolerances due to field conditions, and area practices.
6. Maleable metal, or weather blocking material, required for weather closure with profiled tile.
7. All skylight flashing shall be minimum of (No. 26 galvanized sheet gauge) not less than 0.019 inch corrosion-resistant metal (G90). See Table A for additional options.

Drawing shown depicts the application of all tile profiles. Unless otherwise noted it would apply to either concrete or clay tiles.

OPEN VALLEY - TILE INSTALLED WITH GAP AT CENTER OF VALLEY

MC-17

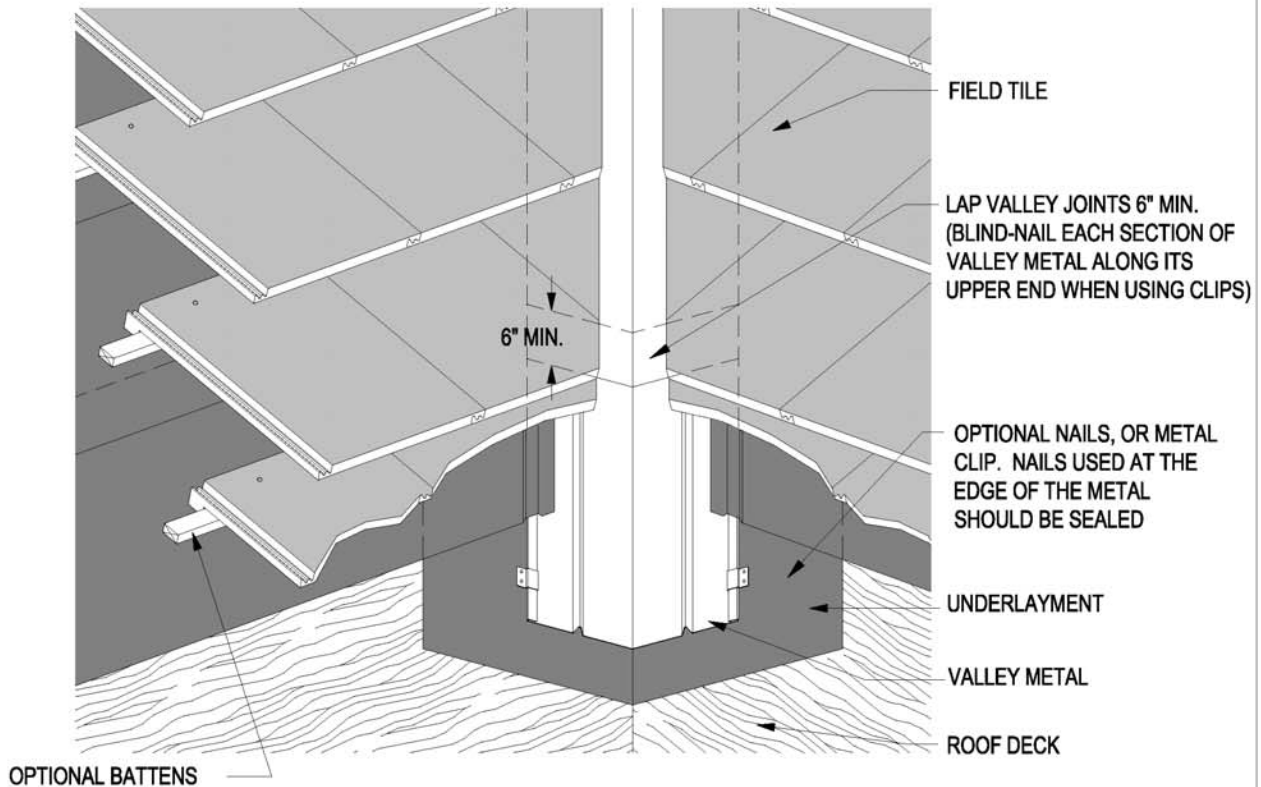

Note: Tile at valleys may be cut to form closed or open metal valley detail. When flat profiled tile is installed as "closed valley" a ribbed valley metal or a single crown valley metal with a batten extension shall be used.

When using standing hem flashing, used woven underlayment method. See MC-03 & MC-17B.

Notes:

1. For recommended underlayment and fastening requirement, see Table 1A and 1B.
2. Cut tile pieces should be secured by one or a combination of the following: (a) code approved adhesive; (b) wire ties (c) batten extension (d) cut tile clip or (e) other code approved fastening device.
3. Metal valley flashing is required to be a minimum of (No. 26 galvanized sheet gauge) not less than 0.019 inch corrosion-resistant metal (G90). See Table A for additional options. Valley flashing shall extend at least 11 inches from center line each way and have a splash diverter rib not less than 1 inch high at flow line formed as part of the flashing.
4. Other valley metal profiles are available. See MC-12B for example.
5. Tile must extend a minimum of 4" over the valley metal.
6. Dimensions shown are minimums and are intended to be approximate to allow for reasonable tolerances due to field conditions, and area practices.
7. Valley details should be designed to suit climatic area, control water runoff, and discharge expected water flows.

Drawing shown depicts the application of all tile profiles. Unless otherwise noted it would apply to either concrete or clay tiles.

THREE RIB VALLEY METAL PROFILES

(ON COUNTER BATTEN)

MC-17A

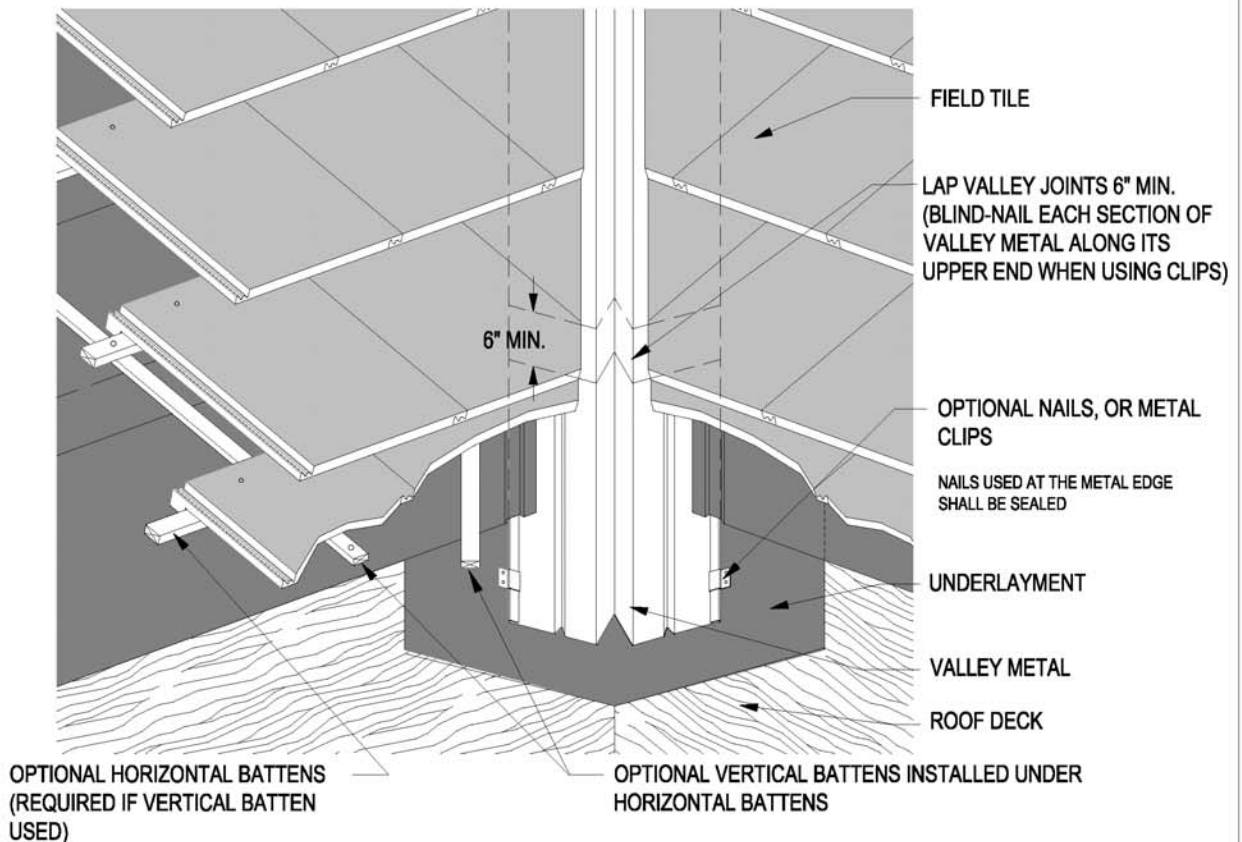

Note: When flat profiled tile is installed as "closed valley" a ribbed valley metal or a single crown valley metal with a batten extension shall be used.

When using standing hem flashing, use woven underlayment method see MC-03 & MC-17B.

Notes:

1. For recommended underlayment and fastening requirement, see Table 1A and 1B.
2. Cut tile pieces should be secured by one or a combination of the following: (a) code approved adhesive; (b) wire ties (c) batten extender (d) cut tile clip or (e) other code approved fastening device.
3. Metal valley flashing is required to be a minimum of (No. 26 galvanized sheet gauge) not less than 0.019 inch corrosion-resistant metal (G90). See Table A for additional options. Valley flashing shall extend at least 11 inches from centerline each way and have a splash diverter rib not less than 1 inch high at flow line formed as part of the flashing.
4. Other valley metal profiles are available. See MC-12B for example.
5. Tile must extend a minimum of 4" over the valley metal
6. Dimensions shown are minimums and are intended to be approximate to allow for reasonable tolerances due to field conditions, and area practices.
7. Valley details should be designed to suit climatic area, control water and discharge expected water flows.

Drawing shown depicts the application of all tile profiles. Unless otherwise noted it would apply to either concrete or clay tiles.

VALLEY METAL - FOR DEEP TROUGH VALLEY

MC-17B

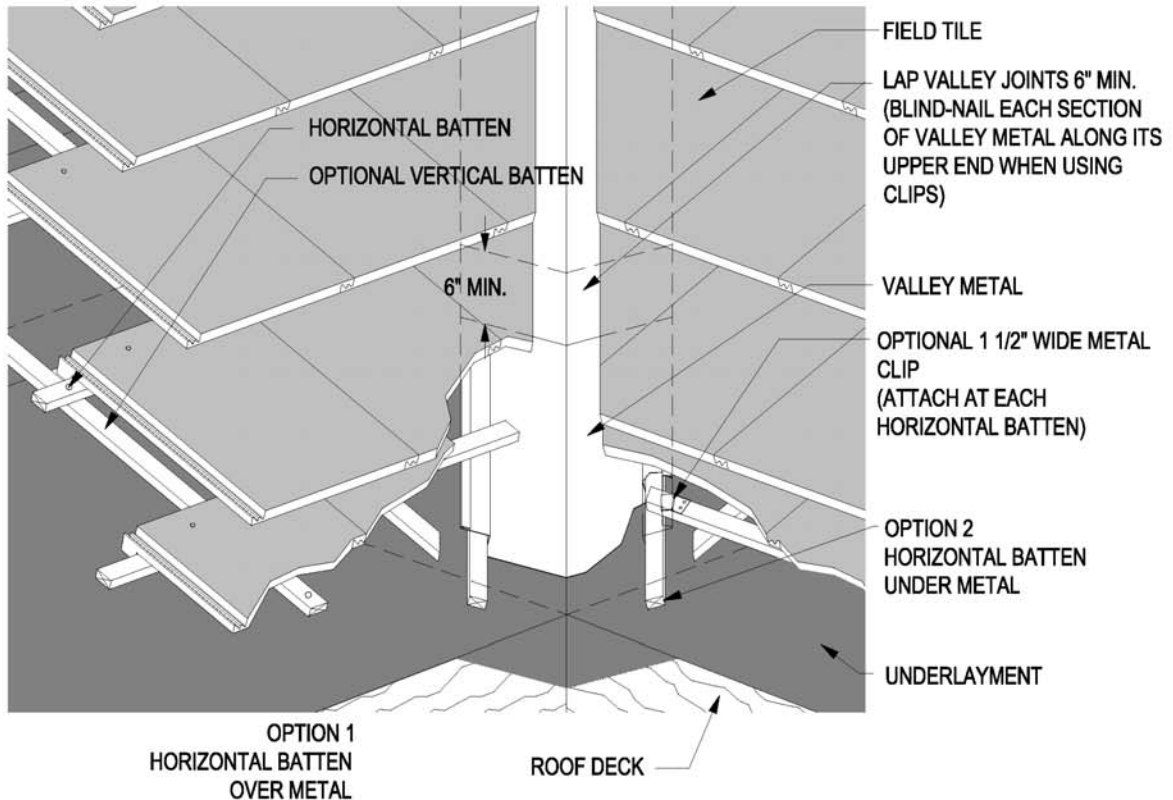

Note: Valley metal shall extend at least 11" from center line each way and shall have a splash diverter rib not less than 1" high at the flow line formed as part of the flashing. Other designs that will handle anticipated water flows may be used upon submission of supporting data indicating that anticipated water flows are equivalent to the code requirements.

Notes:

1. For recommended underlayment and fastening requirement, see Table 1A and 1B.
2. Cut tile pieces should be secured by one or a combination of the following: (a) code approved adhesive; (b) wire ties (c) batten extender (d) cut tile clip or (e) other code approved fastening device.
3. Metal valley flashing is required to be a minimum (No. 26 galvanized sheet gauge) not less than 0.019 inch corrosion-resistant metal (G90). See Table A for additional options. Valley flashing shall extend at least 11 inches from centerline each way and have a splash diverter rib not less than 1 inch high at flow line formed as part of the flashing. On projects with large expansive roof areas and/or long rafter lengths wider valley metal is required. Tile shall extend over valley into valley trough a minimum of 1-1/2".
4. Other valley metal profiles are available. See MC-12B for example.
5. Tile must extend a minimum of 4" over the valley metal.
6. Dimensions shown are minimums and are intended to be approximate to allow for reasonable tolerances due to field conditions, and area practices.
7. Valley details should be designed to consider climatic area, control water and discharge expected water flows.

Drawing shown depicts the application of all tile profiles. Unless otherwise noted it would apply to either concrete or clay tiles.

VALLEY TRANSITIONS

MC-17C

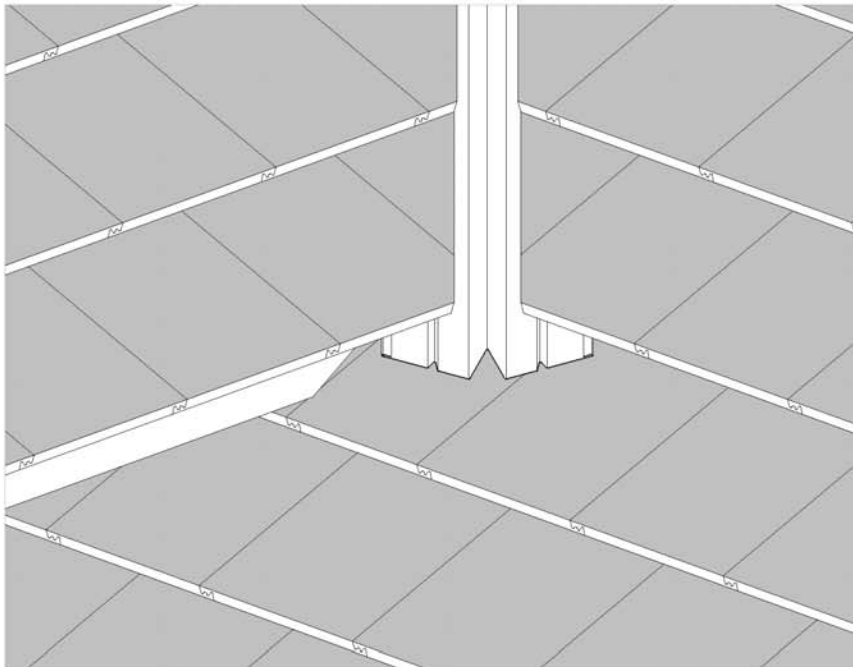

EXAMPLE FOR FLAT OR
LOW PROFILE TILE
THE VALLEY METAL MUST
LAP ONTO THE TILE OF THE
COURSE BELOW THE ROOF
TRANSITION FLASHING

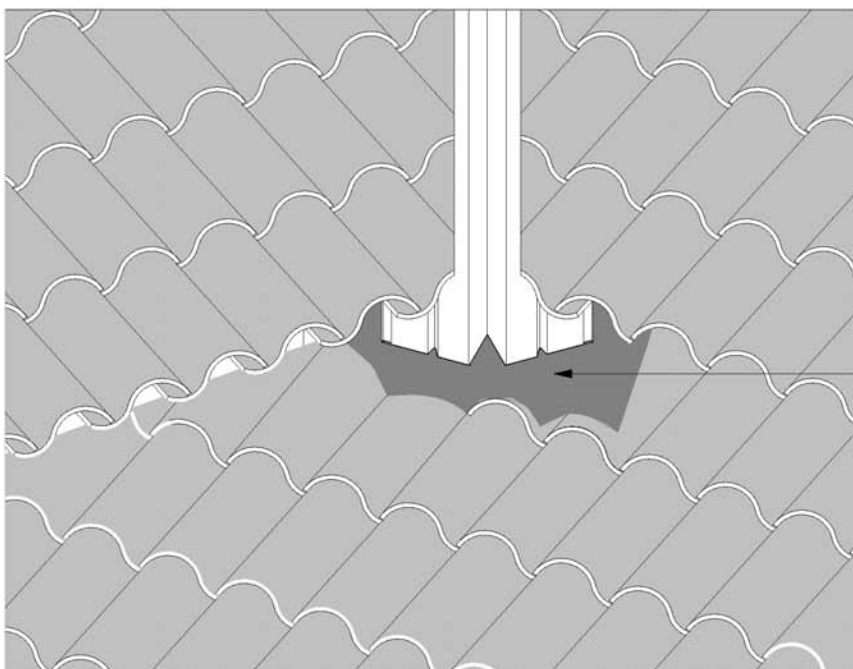

THE VALLEY METAL MUST
LAP ONTO THE TILE OF THE
COURSE BELOW THE ROOF
TRANSITION FLASHING

EXAMPLE FOR HIGH PROFILE
TILE
LEAD SOAKER OR OTHER
APPROVED MALLEABLE
MATERIAL SHOULD BE USED
TO FORM A WATER FLOW
TRANSITION FLASHING

Drawing shown depicts the application of all tile profiles. Unless otherwise noted it would apply to either concrete or clay tiles.

BOXED-IN SOFFIT

MC-17D

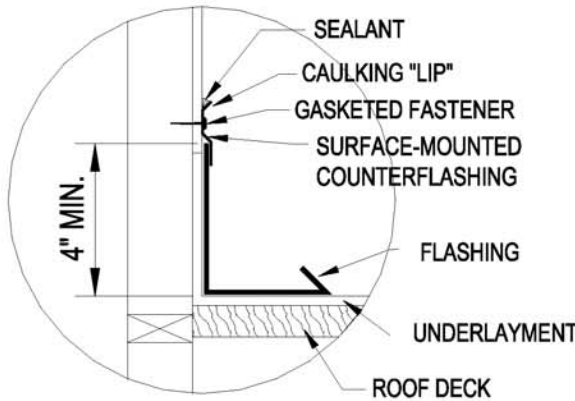
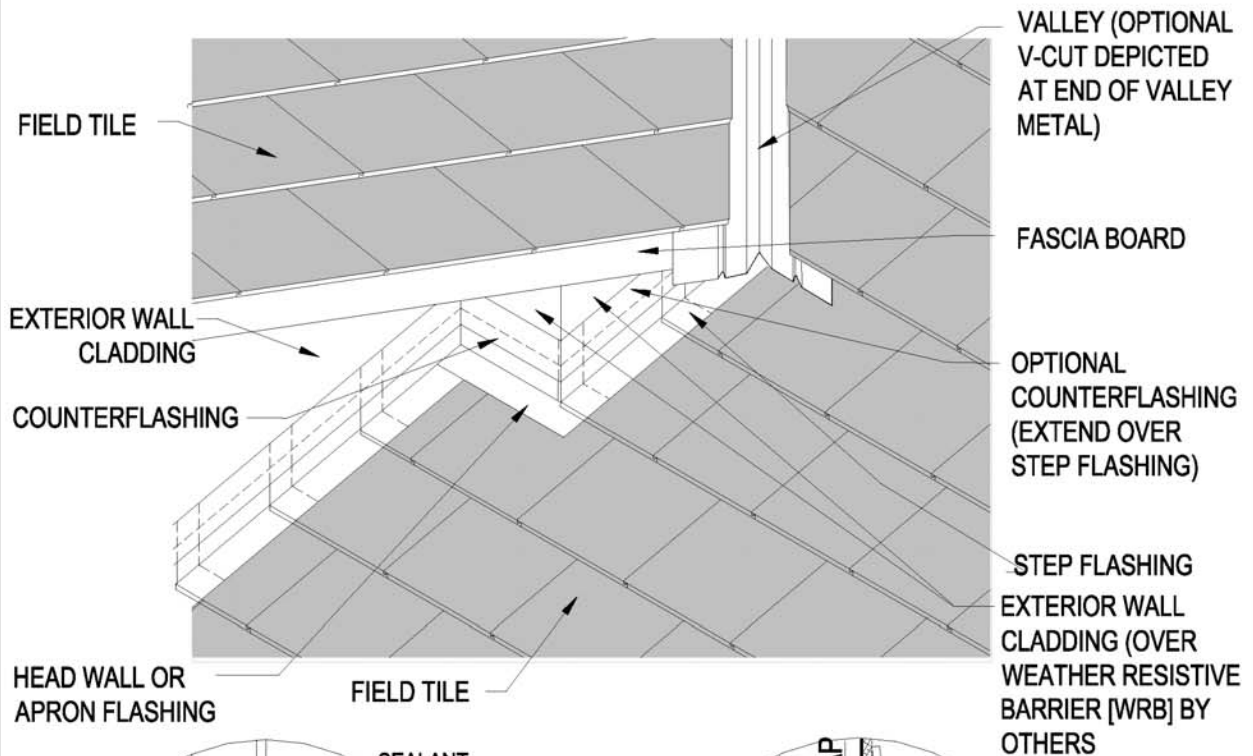

SURFACE MOUNT FLASHING

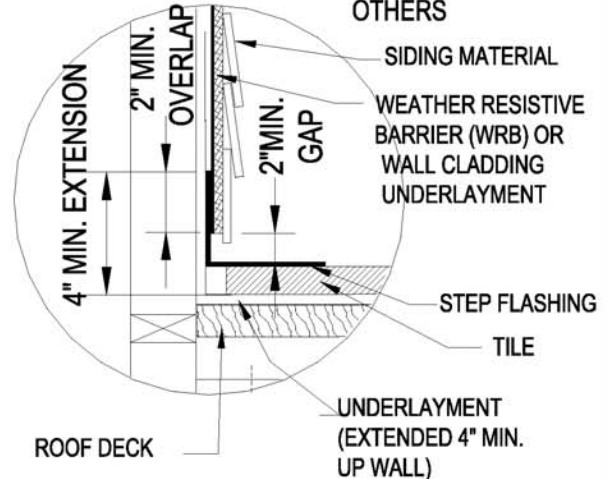

NOTES:

1. Surface-mounted flashing may be sufficient in some mild climates. However, concealed or insert flashings such as "Z" metal or Stucco-type two-piece reglet and counter flashing or step flashing, are recommended in wet climates, particularly with stucco or other permeable cladding systems.
2. Dimensions shown are minimums and are intended to be approximate to allow for reasonable tolerances due to field conditions, and are practice.

Drawing shown depicts the application of all tile profiles. Unless otherwise noted it would apply to either concrete or clay tiles.

HIP AND RIDGE (Optional Method)

MC-18

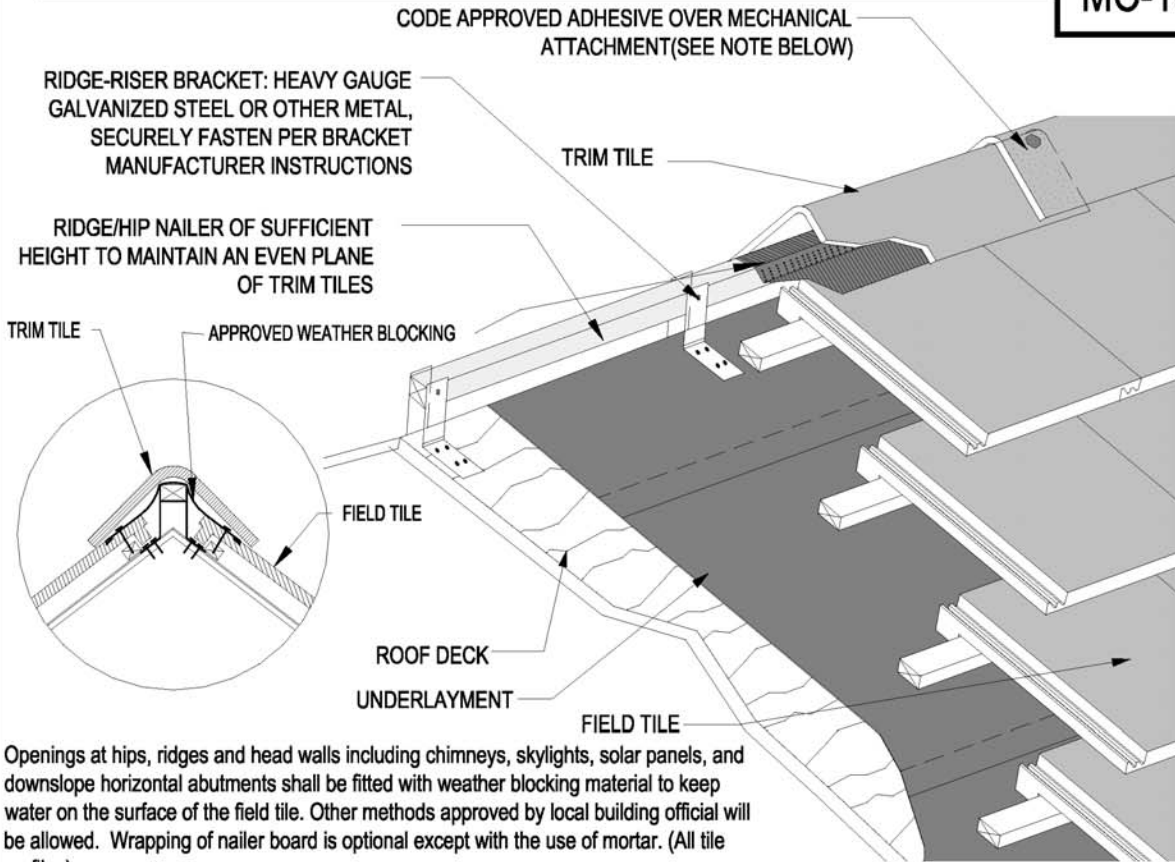

Openings at hips, ridges and head walls including chimneys, skylights, solar panels, and downslope horizontal abutments shall be fitted with weather blocking material to keep water on the surface of the field tile. Other methods approved by local building official will be allowed. Wrapping of nailer board is optional except with the use of mortar. (All tile profiles)

Notes:

1. For recommended underlayment and fastening requirement, see Table 1A and 1B.
2. All hip and ridge tile are required to have a code approved adhesive between laps of trim tile to cover nail hole and create a bond between trim tiles.
3. Tiles to be cut in a manner to properly conform to the method of weatherblocking material used.
4. Battens for tiles with protruding anchor lugs are optional for slopes between 3:12 and 7:12. Direct deck attachment of tile as approved by local building official is allowed.
5. Dimension shown are minimums and are intended to be approximate to allow for reasonable tolerance due to field conditions, and area practices.
6. Orientation and termination of ridge trim tiles may vary.

HIP BOARD OR NAILER
 HIPS TO BE SEALED WITH UV RESISTANT MATERIAL, MORTAR, ROOF CEMENT, PREFORMED PLASTIC OR SELF-ADHERING FLASHING WHERE TILE MEETS HIP BOARD
 ROOFERS CEMENT OR TILE ADHESIVE MUST BE APPLIED AT HEADLAP TO COVER NAIL HOLE
 PROVIDE MINIMUM 2" HEADLAP
 HOLD BACK HIP NAILER APPROX. 6" FROM EAVE EDGE

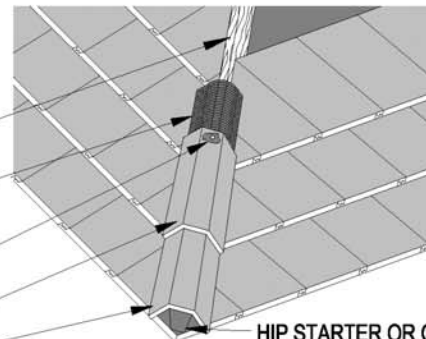

Drawing shown depicts the application of all tile profiles. Unless otherwise noted it would apply to either concrete or clay tiles.

HIP AND RIDGE

MC-18A

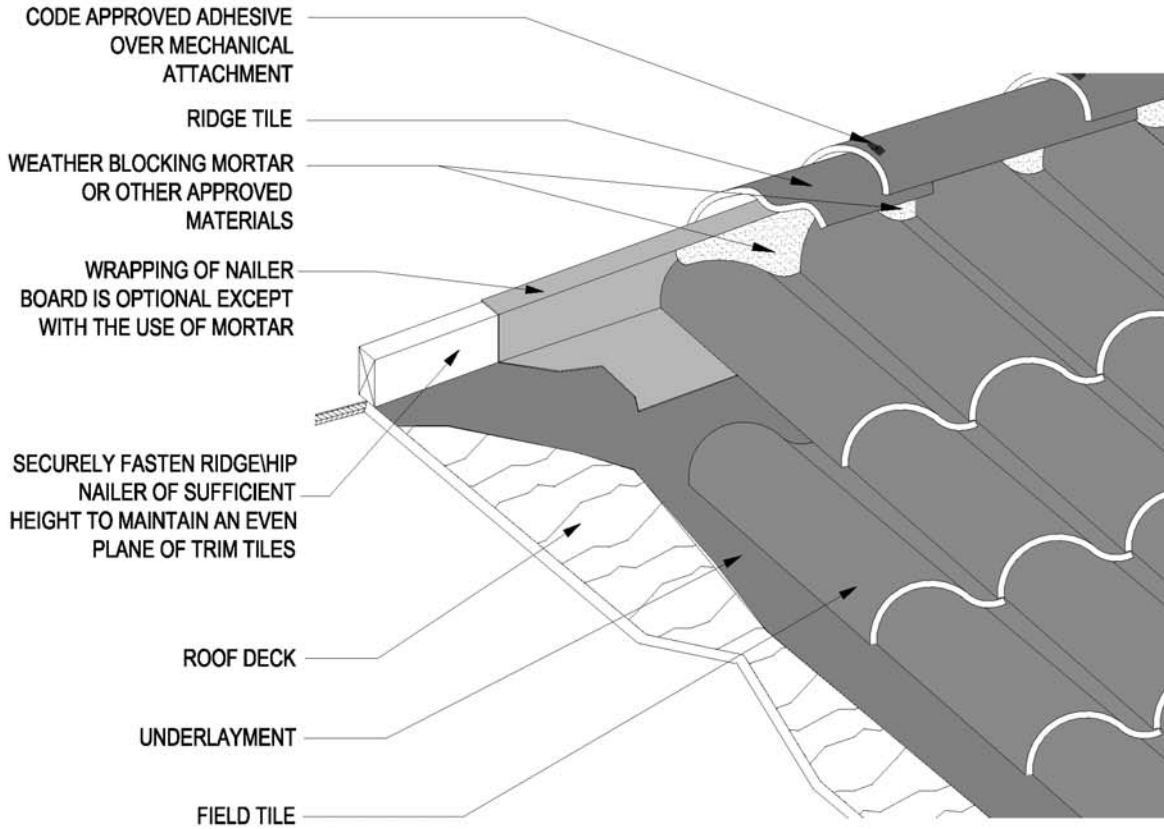

Openings at hips, ridges and head walls including chimneys, skylights, solar panels, and downslope horizontal abutments shall be fitted with weather blocking material to keep water on the surface of the field tile. Other methods approved by local building official will be allowed.

Wrapping of nailer board is optional except with the use of mortar. (All profiles of tile)

Notes:

1. For recommended underlayment and fastening requirement, see Table 1A and 1B.
2. All hip and ridge tile are required to have a code approved adhesive or special clip between laps of trim tile to cover nail hole and create a bond between ridge tiles.
3. Battens for tiles with protruding anchor lugs are optional for slopes between 3:12 and 7:12. Direct deck attachment of tile as approved by local building official will be allowed.
4. Dimension shown are minimum and are intended to be approximate to allow for reasonable tolerance due to field conditions, and are practices.

Drawing shown depicts the application of all tile profiles. Unless otherwise noted it would apply to either concrete or clay tiles.

VENTED RIDGE (Optional Method)

MC-18B

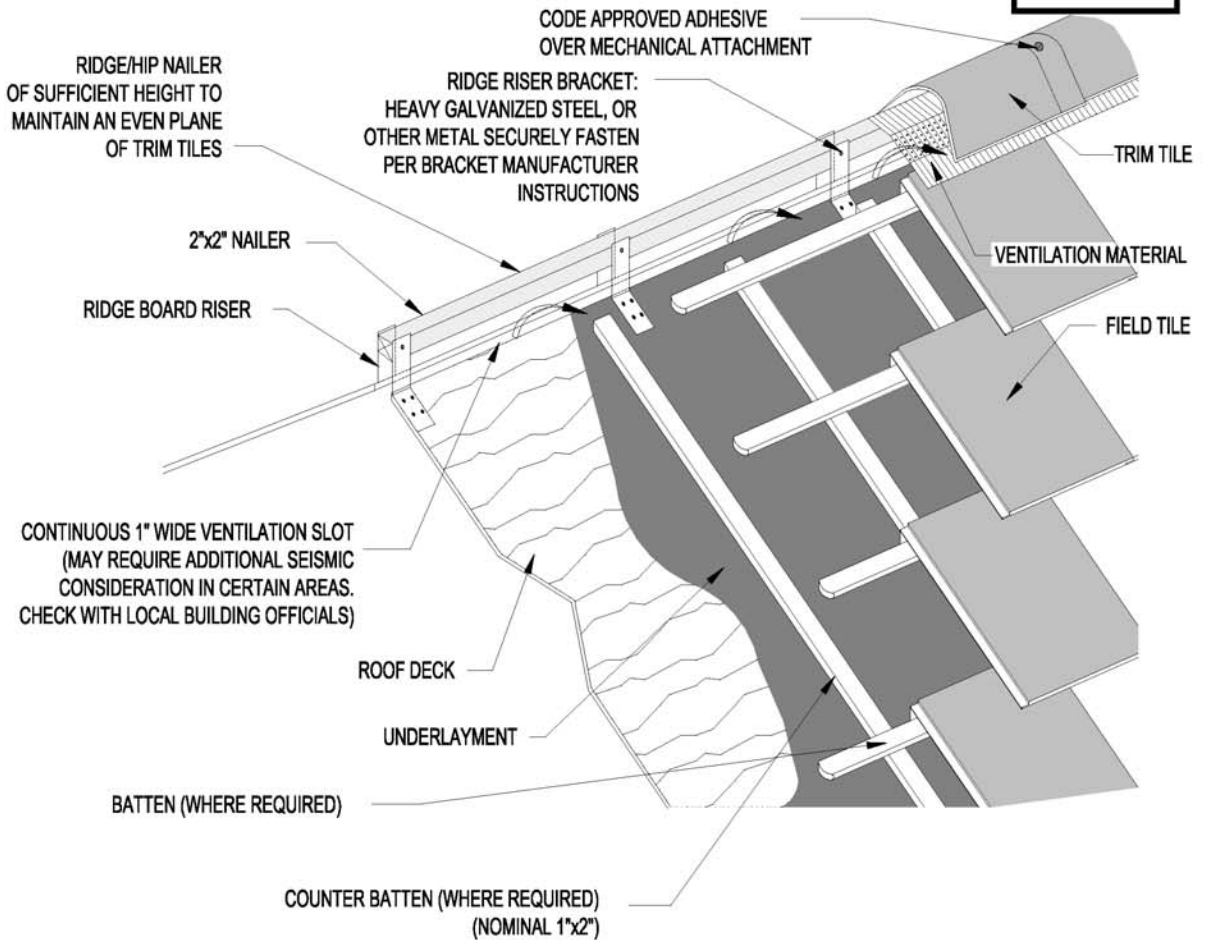

Notes:

1. Refer to vent manufacturer instructions for products and limitations.
2. Ensure the vent material/weather blocking and/or ridge tile will provide sufficient coverage over field tile, if top course is held down from ridge to allow for ventilation cut out or slot in sheathing.
3. For recommended underlayment and fastening requirement, see Table 1A and 1B.
4. Dimension shown are minimums and are intended to be approximate to allow for reasonable tolerance due to field conditions, and area practices.

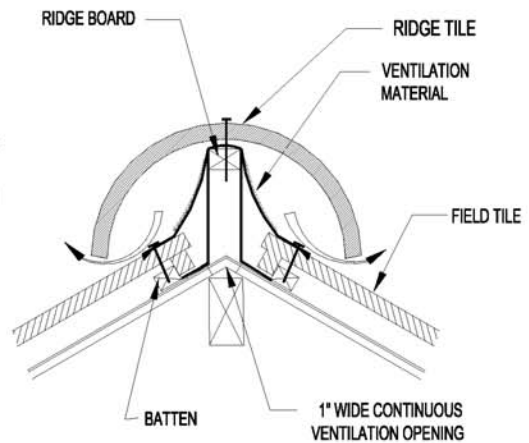

Drawing shown depicts the application of all tile profiles. Unless otherwise noted it would apply to either concrete or clay tiles.

PARAPET OR MANSARD CONDITION

MC-18C

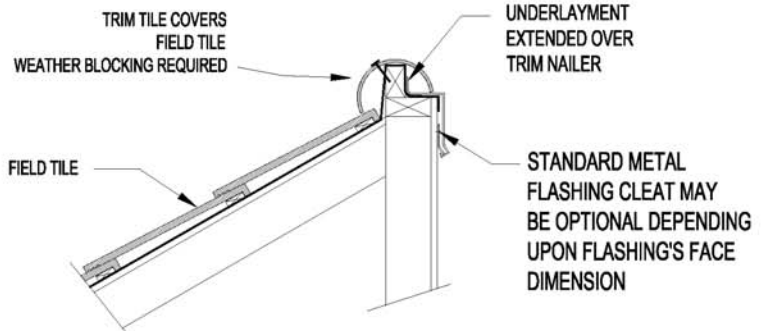

Notes: Detail may vary depending on type of tile being used. Two-piece tile method may replace requirement for metal flashing.

METAL CAP CONDITION

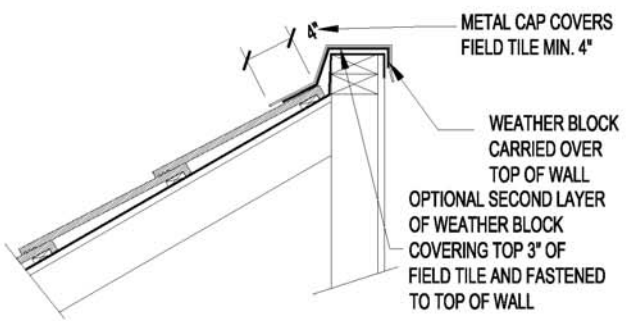

Notes:

1. For recommended underlayment and fastening requirement, see Table 1A and 1B.
2. Dimension shown are minimums and are intended to be approximate to allow for reasonable tolerance due to field conditions, and area practices.

Drawing shown depicts the application of all tile profiles. Unless otherwise noted it would apply to either concrete or clay tiles.

RAKE FLASHING - COUNTER BATTEN SYSTEM (Where Required)

MC-19

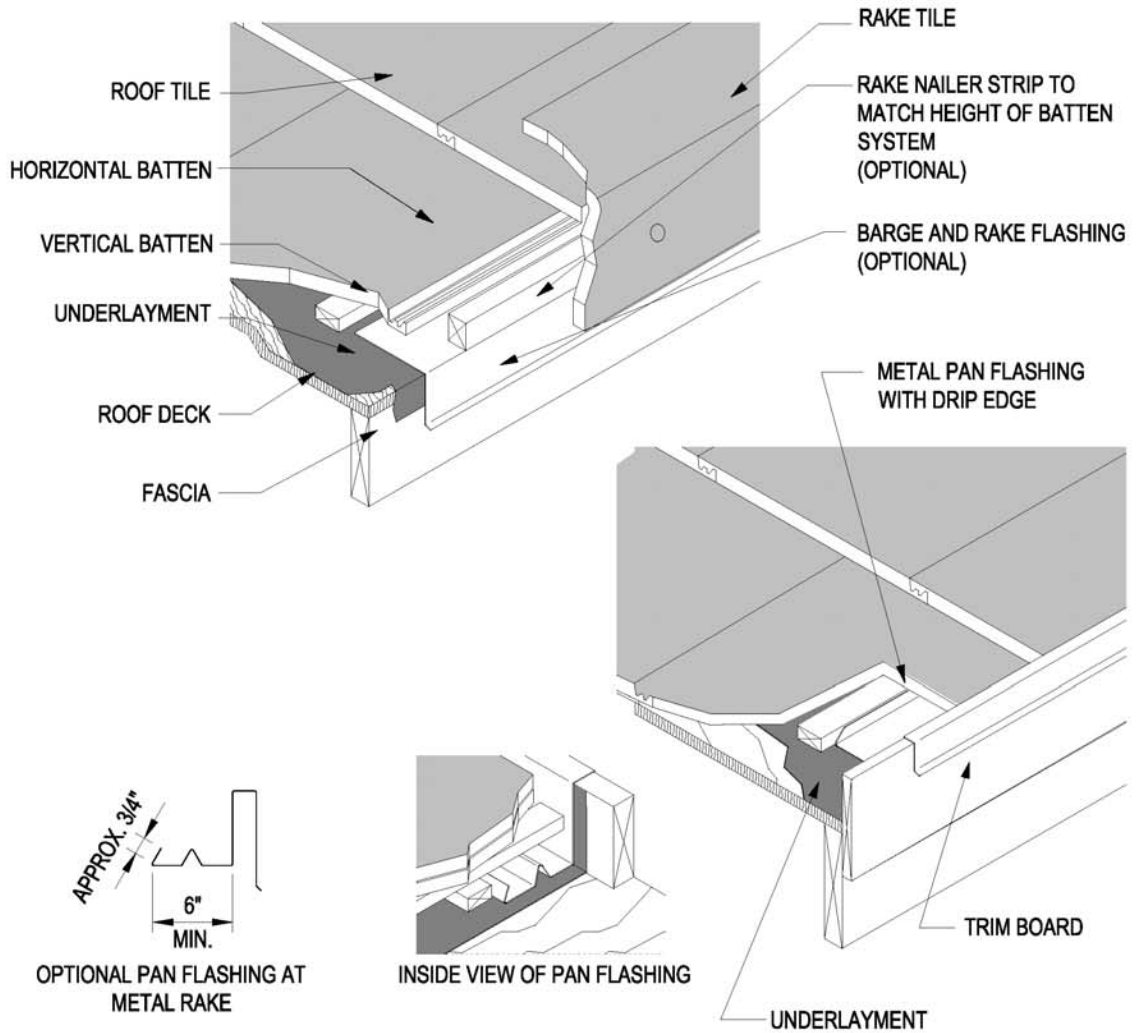

Notes:

1. For recommended underlayment and fastening requirement, see Table 1A and 1B.
2. Sheet metal Flashing shall be a minimum of (No. 26 galvanized sheet gauge) not less than 0.019 inch corrosion-resistant metal (G90). See Table A for additional options.
3. Dimensions shown are minimums and are intended to be approximate to allow for reasonable tolerances due to field conditions, and local area practice.
4. Rake flashing and wood nailer/trim board shall be raised above the roof deck to a height greater than the height of the installed roof tile.
5. Rake tiles must be fastened into a minimum 2" nominal gable fascia board, gable trim, or equivalent in dimension from multiple pieces.

Drawing shown depicts the application of all tile profiles. Unless otherwise noted it would apply to either concrete or clay tiles.

Appendix A

RAKE FLASHING - EXAMPLES

SEE DRAWING MC-12B FOR ADDITIONAL FLASHING INFORMATION

MC-19A

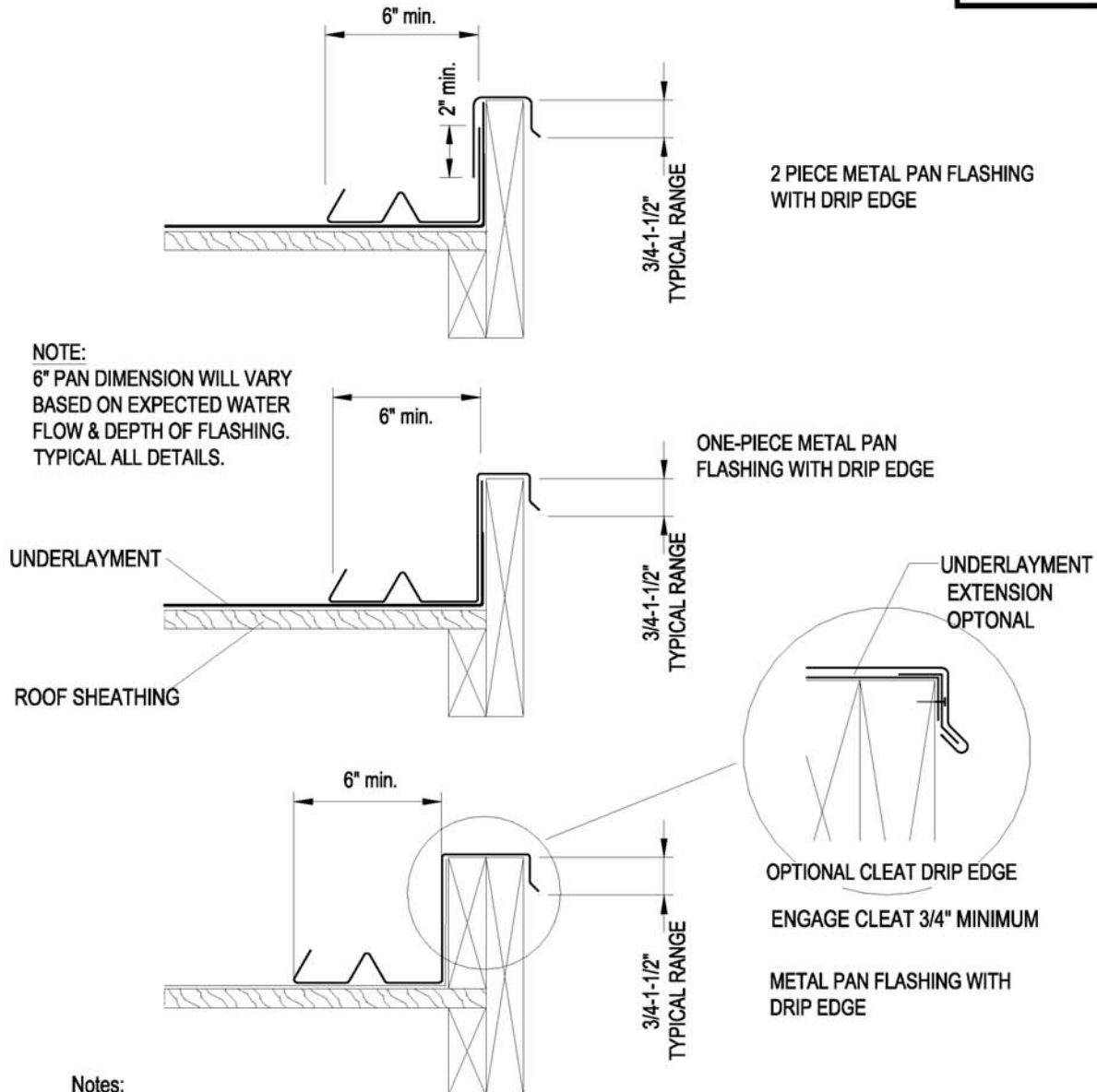

Notes:

1. Flashing details may vary according to local weather conditions, roof size, location, slope of roof and contributory run-off area.
2. Underlayment will extend a minimum of 4" up vertical wood blocking, wall, or to the top of fascia or gable trim.
3. Sheet metal flashing should be a minimum of (No. 26 galvanized sheet gauge) not less than 0.019 inch corrosion-resistant metal (G90). See Table A for additional options.
4. Dimensions shown are minimums and are intended to be approximate to allow for reasonable tolerances due to field conditions, and area practices.
5. Rake flashing and wood nailer/trim board will be raised above the roof deck to a height greater than the height of the installed roof tile.

Drawing shown depicts the application of all tile profiles. Unless otherwise noted it would apply to either concrete or clay tiles.

RAKE TILE INSTALLATION

MC-19B

FOR ADDITIONAL FASTENING IN REGIONS SUBJECT TO HIGH WINDS OR SNOW ACCUMULATION, A MINIMUM 1" DAB OF CODE APPROVED ADHESIVE IS RECOMMENDED AT OVERLAP

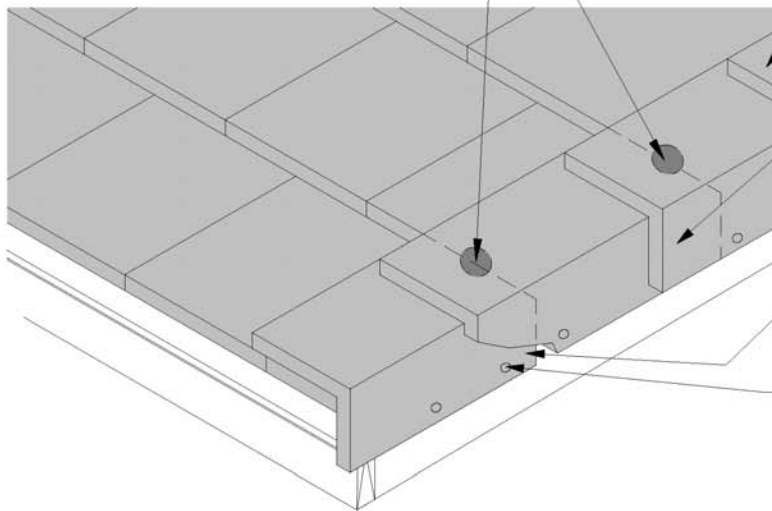

FACTORY-FINISHED BUTT END EXPOSED; PLACE THICK END UPSLOPE TOWARD RIDGE

BUTT RAKE TILES TO COURSE ABOVE

CUT OFF HEAD END OF FIRST RAKE TILES SO FACTORY-FINISHED BUTT END IS FLUSH WITH EAVE COURSE TILES

TWO CORROSION-RESISTANT FASTENERS, PER RAKE TILE, OF SUFFICIENT LENGTH TO PENETRATE THE 2x NAILER OR BARGE BOARD A MINIMUM OF 3/4". HEAD OF FASTENERS SHALL BE LARGER THAN HOLE IN TRIM TILES.

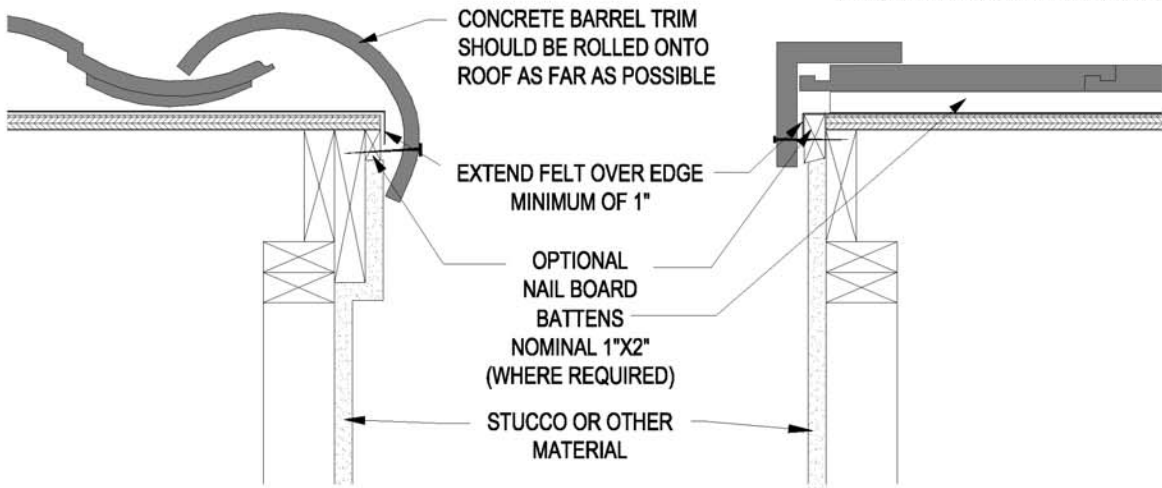

CONCRETE BARREL TRIM SHOULD BE ROLLED ONTO ROOF AS FAR AS POSSIBLE

EXTEND FELT OVER EDGE MINIMUM OF 1"

OPTIONAL NAIL BOARD BATTENS NOMINAL 1"x2" (WHERE REQUIRED)

STUCCO OR OTHER MATERIAL

Notes:

1. Dimensions shown are minimums and are intended to be approximate to allow for reasonable tolerances due to field conditions, and area practices.
2. Rake tiles must be fastened into a minimum nominal 2" gable fascia or equivalent in dimension.
3. The fasteners must penetrate a minimum of 3/4" into dimensional wood lumber.
4. See Table 1A for additional fastening instructions.

Drawing shown depicts the application of all tile profiles. Unless otherwise noted it would apply to either concrete or clay tiles.

Appendix A

GABLE \ EAVE INSTALLATION - BARREL TILE

(CLAY TILE INSTALLATIONS)

MC-20

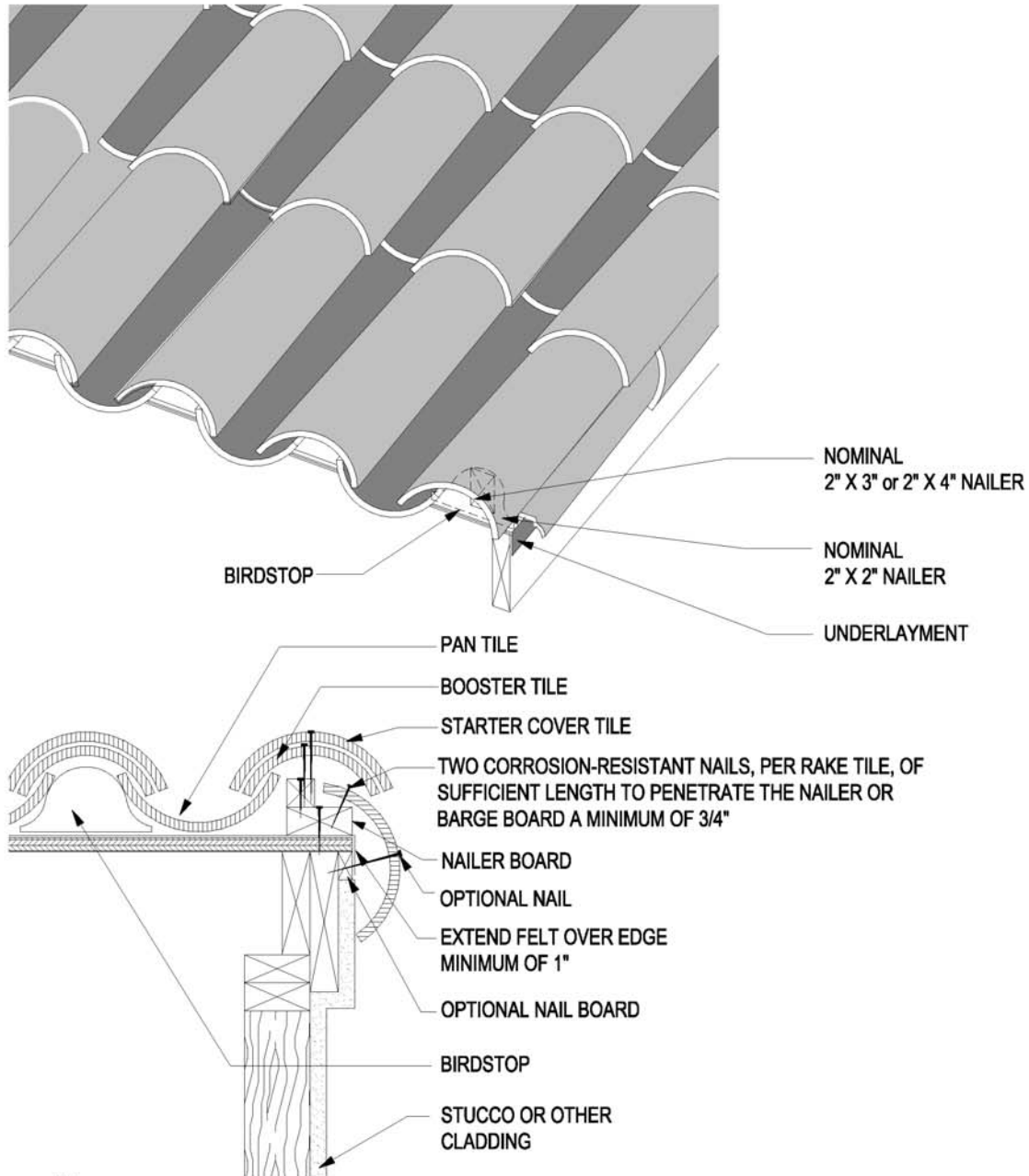

Notes:

1. Dimensions shown are minimums and are intended to be approximate to allow for reasonable tolerances due to field conditions, and area practice.
2. See Table 1A for additional fastening requirements.

Drawing shown depicts the application of all tile profiles. Unless otherwise noted it would apply to either concrete or clay tiles.

GABLE \ EAVE INSTALLATION

(CLAY TILE INSTALLATIONS)

MC-20A

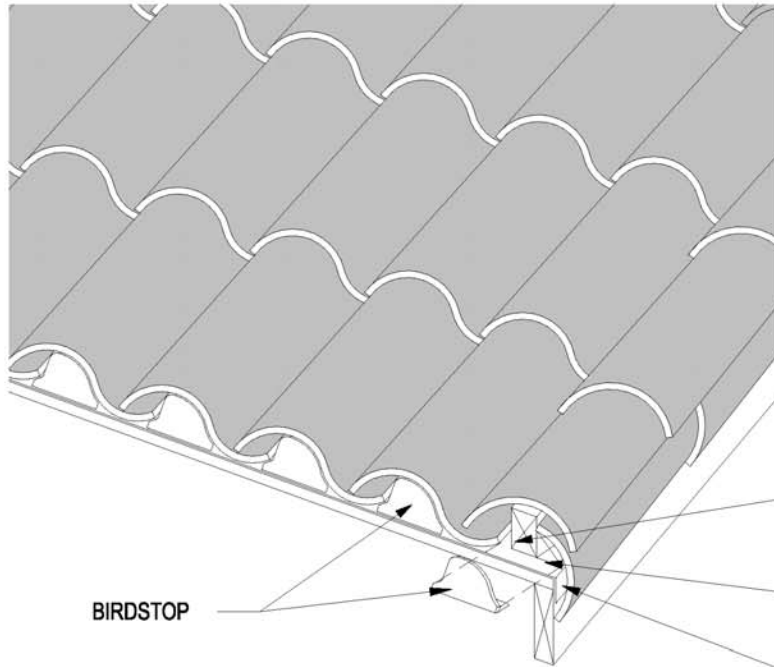

EAVE DRIP EDGE FLASHING
NOT SHOWN FOR CLARITY

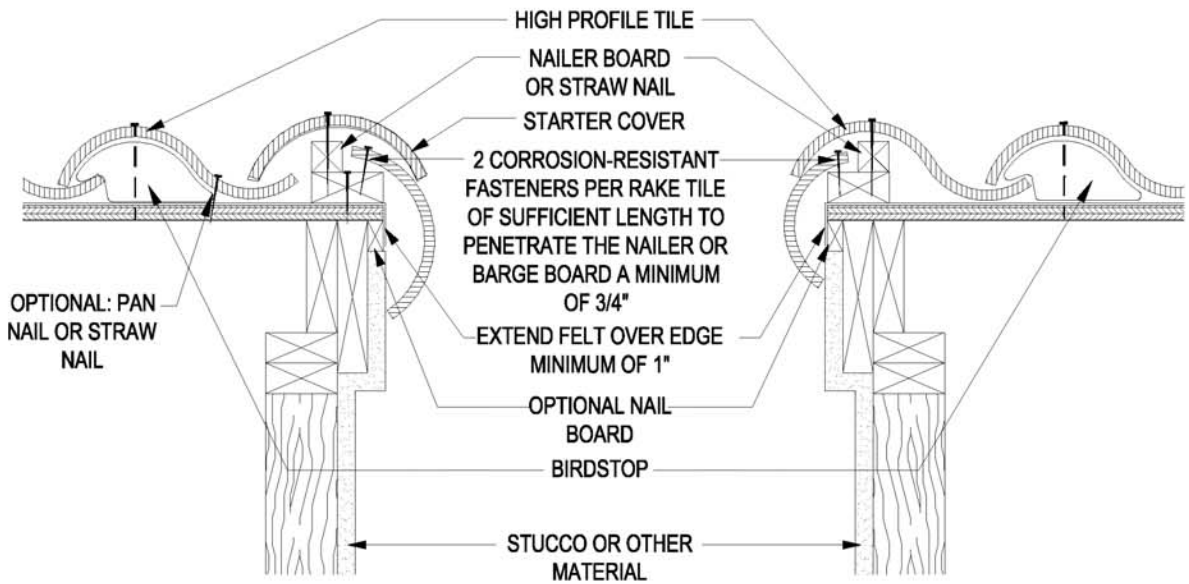
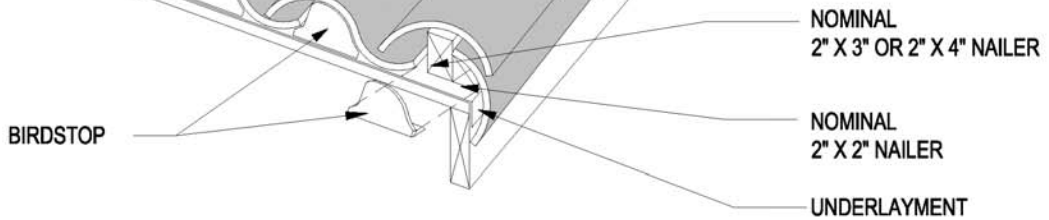

Notes:

1. Dimensions shown are minimums and are intended to be approximate to allow for reasonable tolerances due to field conditions.

Drawing shown depicts the application of all tile profiles. Unless otherwise noted it would apply to either concrete or clay tiles.

Appendix A

ROOF VENTS (OFF RIDGE)

MC-21

VENTS TO BE INSTALLED PER VENT MANUFACTURER INSTRUCTIONS

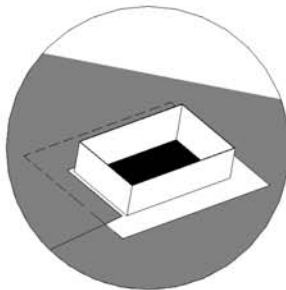
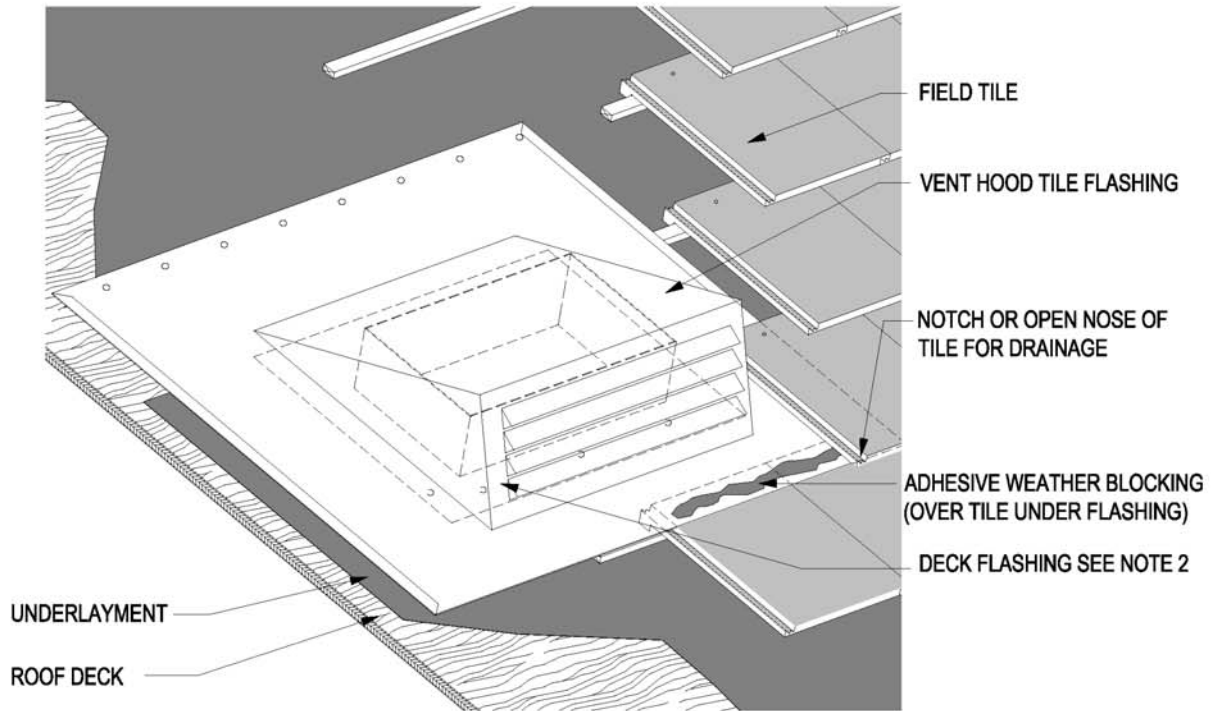

UNDERLAYMENT DETAIL AT DECK FLASHING

HEIGHT OF FLASHING TO BE MINIMUM 1/2"

NOTE: CHECK LOCAL CODE REQUIREMENTS FOR VERMIN SCREENING

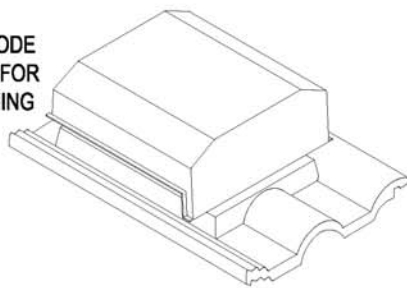

VENTED TILES AVAILABLE TO MATCH INDIVIDUAL TILE MANUFACTURER PROFILES.

Notes:

1. One layer of No. 30 asphalt-saturated felt complying with ASTM D-226 (ASTM D4869 Type IV) or approved equal is required as a minimum underlayment on all tile roof applications. Other underlayments as approved by local building officials will be allowed.
2. A secondary flashing, as depicted in the left inset drawing, is required around the penetration to prevent moisture intrusion should water reach the underlayment, under the roof tile. This secondary or deck flashing is required with all tiles.
3. For climates with wind driven rain or blowing snow, consult local building official for approved application.
4. Where flashing is of metal should be minimum of (No. 26 galvanized sheet gauge) not less than 0.019 inch corrosion-resistant metal (G90). See Table A for additional options.

Drawing shown depicts the application of all tile profiles. Unless otherwise noted it would apply to either concrete or clay tiles.

SLOPE CHANGE APPLICATIONS

MC-22

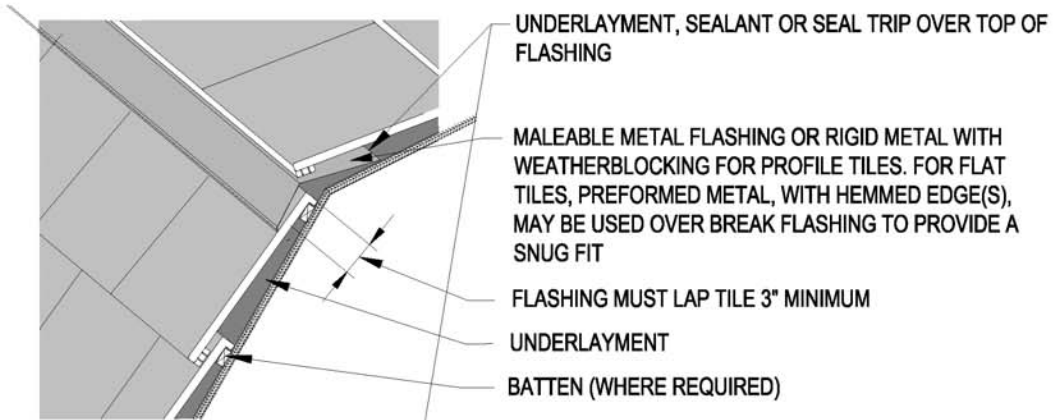

**OPTION 1
WITH METAL**

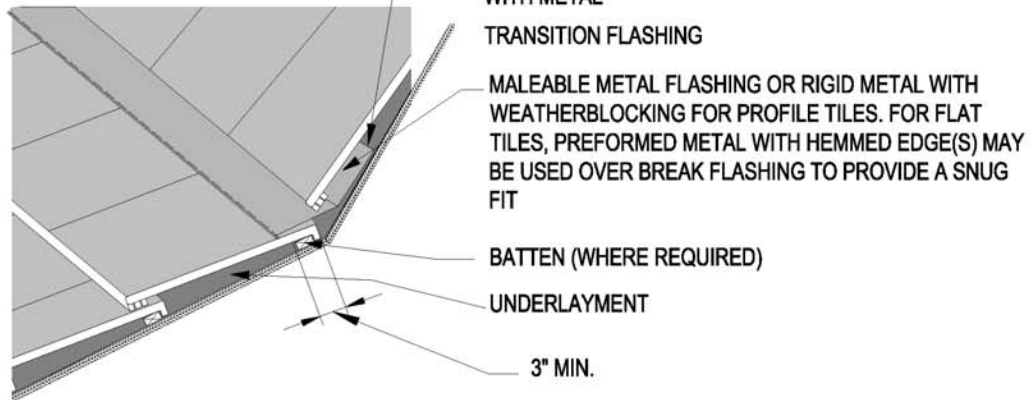

**OPTION 2
WITHOUT METAL**

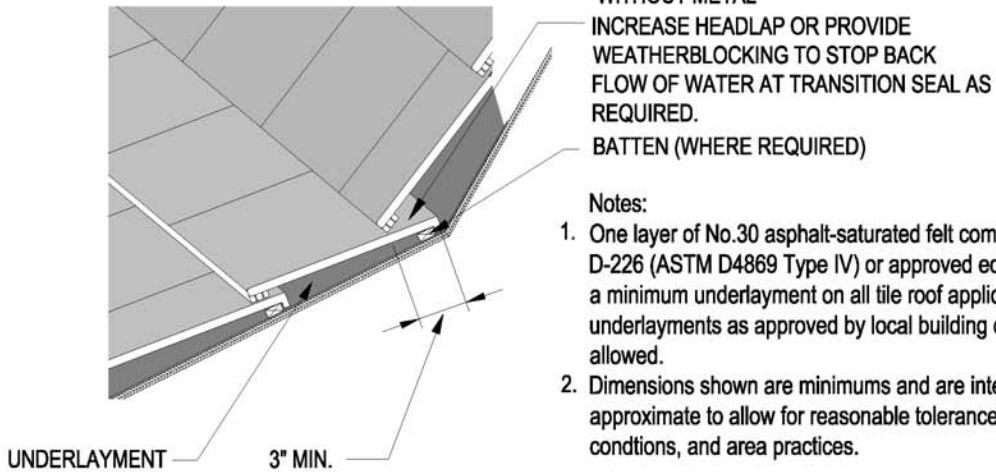

Notes:

1. One layer of No.30 asphalt-saturated felt complying with ASTM D-226 (ASTM D4869 Type IV) or approved equal is required as a minimum underlayment on all tile roof applications. Other underlayments as approved by local building officials will be allowed.
2. Dimensions shown are minimums and are intended to be approximate to allow for reasonable tolerances due to field conditions, and area practices.

Drawing shown depicts the application of all tile profiles. Unless otherwise noted it would apply to either concrete or clay tiles.

GUTTERS

MC-23

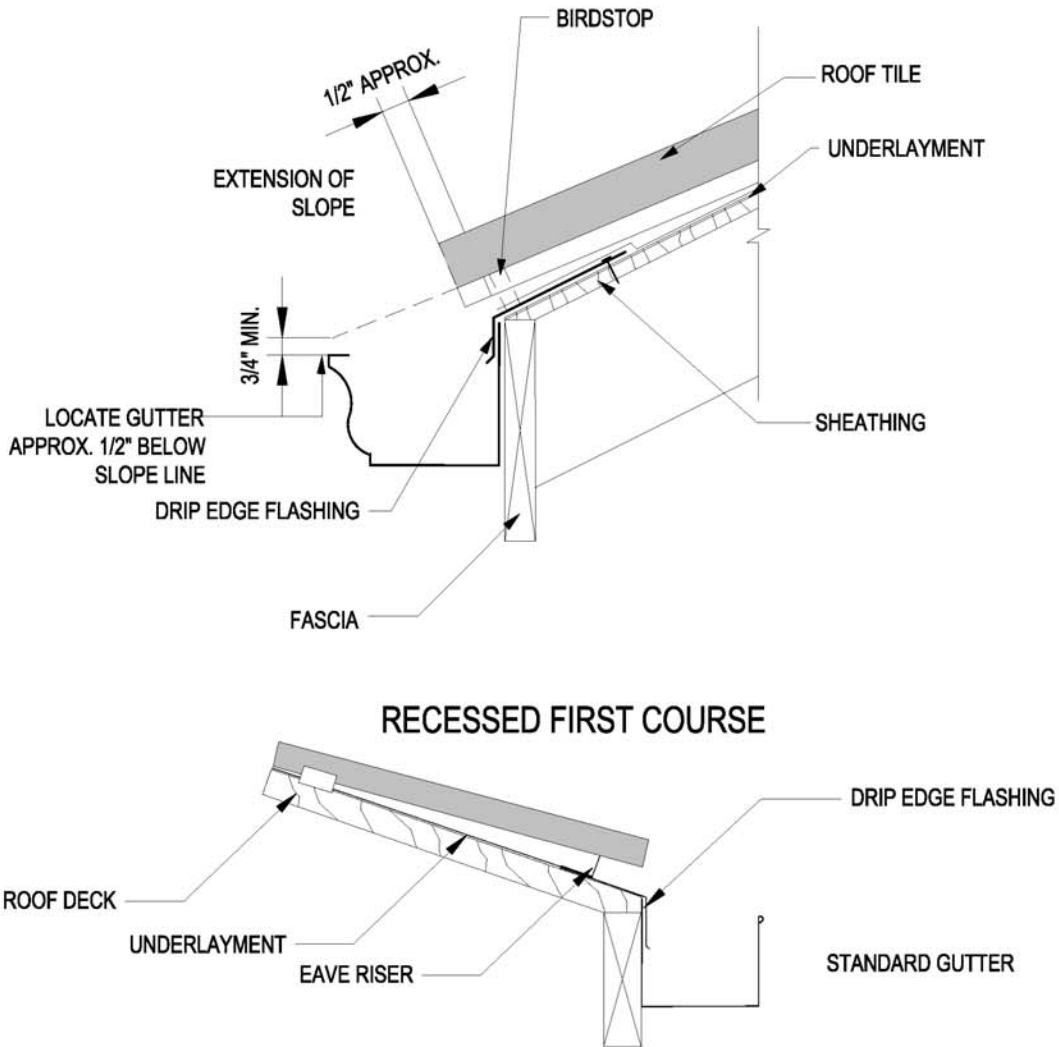
**Notes:**

This drawing is included to show one style of gutter installation since gutter conditions will vary by climate conditions. Please contact your local gutter manufacturer for specific installation requirements.

Notes:

1. For recommended underlayment and fastening requirement, see Table 1A and 1B.
2. An eave drip edge flashing is required with: stucco fascia, EIFS (Exterior Insulated Finish System) and flush fascia perimeter edges.
3. Battens for tiles with protruding anchor lugs are optional for slopes between 3:12 less than or equal to 7:12. Direct deck nailing attachment of tile may be permissible.
4. Eave closure should be of height equal to combined thickness of batten system and thickness of one course of tile.
5. Dimensions shown are minimums and are intended to be approximate to allow for reasonable tolerances due to field conditions.

Drawing shown depicts the application of all tile profiles. Unless otherwise noted it would apply to either concrete or clay tiles.

TILE REPAIRS/REPLACEMENT

MC-24

When replacing an individual tile, one method is to remove the broken tile by breaking into smaller pieces with a hammer or other acceptable tool. This will minimize the disturbance of surrounding tiles. Once the tile has been removed, any remaining fasteners should be removed and the resulting hole in the underlayment cleaned and patched.

FOR APPLICATIONS WITHOUT BATTENS

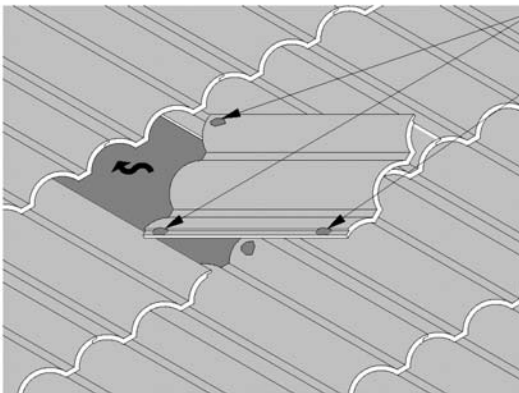

YES (PROPER LOCATION)

NO (IMPROPER LOCATION)

TILE ADHESIVE (CODE APPROVED, SEE PAGE 5)

FOR APPLICATIONS WITH BATTENS

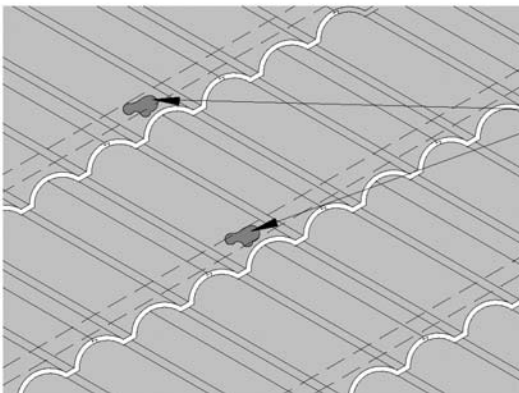

Wedge surrounding tiles up and slide new tile into place.
FOR SLOPES OVER 7:12 (Battens required)

Remove broken tile and fastener. Wedge surrounding tiles, apply code approved roof tile adhesive and slide new tile in place.

TILE ADHESIVE (CODE APPROVED, SEE PAGE 5)

Note:

The replacement tile may be slipped into place and fastened with an approved roof tile adhesive. It is important that the adhesive is placed in a position that will assure contact with adjacent tiles without affecting the flow of water. If adhesive is applied to the interlocking water channel, it must be placed above the headlap to avoid water damming.

Remove any shim that had been used during the repair process and ensure that all tiles surrounding the replaced piece properly fit and are seated.

Drawing shown depicts the application of all tile profiles. Unless otherwise noted it would apply to either concrete or clay tiles.

TILE REPAIR \ REPLACEMENT - CONTINUED

MC-24A

OPTIONAL METHODS OF REPLACEMENT TILE ATTACHMENT
CLIPS / HOOKS INSTALLED PER CLIP / HOOK MANUFACTURER INSTRUCTIONS

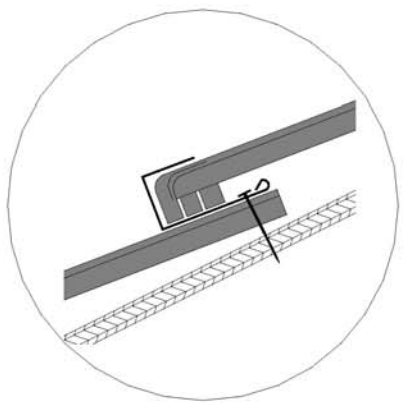
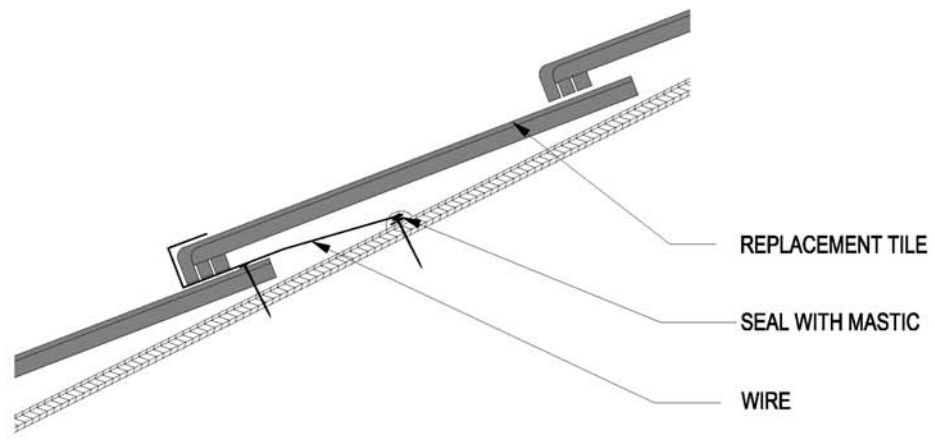

'L' HOOK

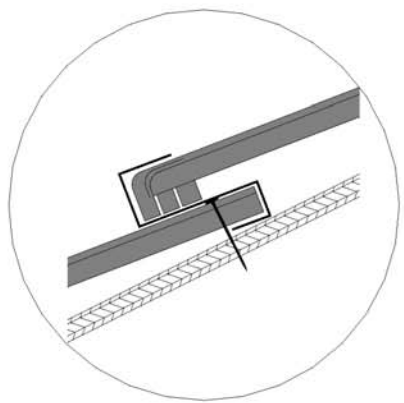

'S' HOOK

Notes:

1. Clear area of debris where broken tile is to be replaced. Remove fasteners from the previous tile. Fasteners may be removed by using a slate ripper or, in the case of some screws, use a hacksaw blade.
2. Lift nose of tile in course above. Then slide replacement tile, underneath the overlapping tile and over the hook, then slide tile into the hook and down until bracket "L" hooks underneath top of course below.
3. Adjust replacement tile to align or interlock (depending on the tile type) with tiles to either side.
4. Another method is to fasten a 12 gauge copper wire into the deck, replacing the tile and then bending the exposed wire. A sheet metal (e.g. copper) strip can also be used over the tile nose.
5. Make adjustment for field conditions.

Drawing shown depicts the application of all tile profiles. Unless otherwise noted it would apply to either concrete or clay tiles.

SPECIALTY CONDITIONS - PRE-ENGINEERED ROOF

MC-25

Installation on Metal Deck - Considerations Ribs Running Parallel To Roof Slope

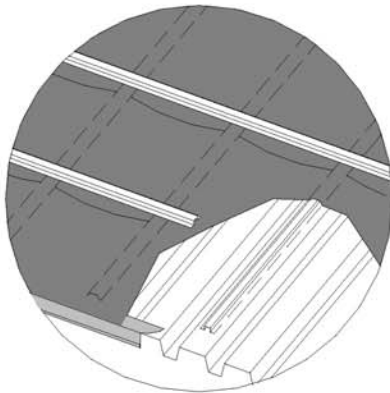
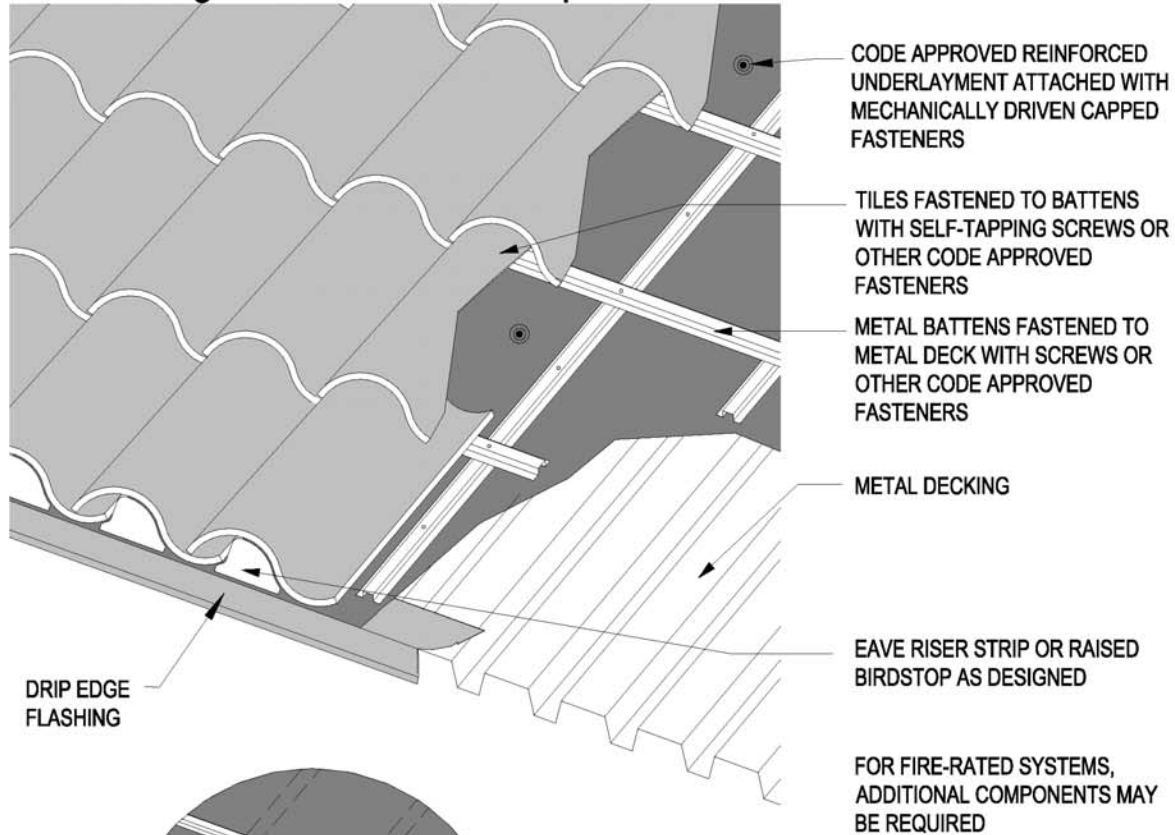

The pre-engineered roof systems are included for informational purposes only and are not recognized under evaluation reports for roof tiles

Notes:

1. Vertical battens to be metal or as approved or designed as per metal deck manufacturer.
2. For recommended underlayment and fastening requirement, see Table 1A and 1B.
3. A drip edge flashing is required with: stucco fascia, EIFS (Exterior Insulated Finish System) and flush fascia perimeter edges.
4. Eave closure should be of height equal to combined thickness of batten system and thickness of one course of tile.
5. Dimensions shown are minimums and are intended to be approximate to allow for reasonable tolerances due to field conditions.

Drawing shown depicts the application of all tile profiles. Unless otherwise noted it would apply to either concrete or clay tiles.

SPECIALTY CONDITIONS - PRE-ENGINEERED ROOF

MC-25A

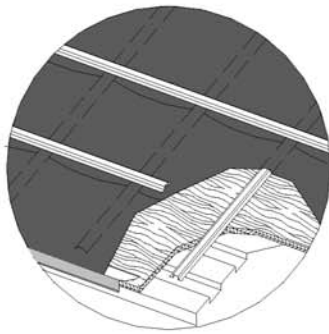
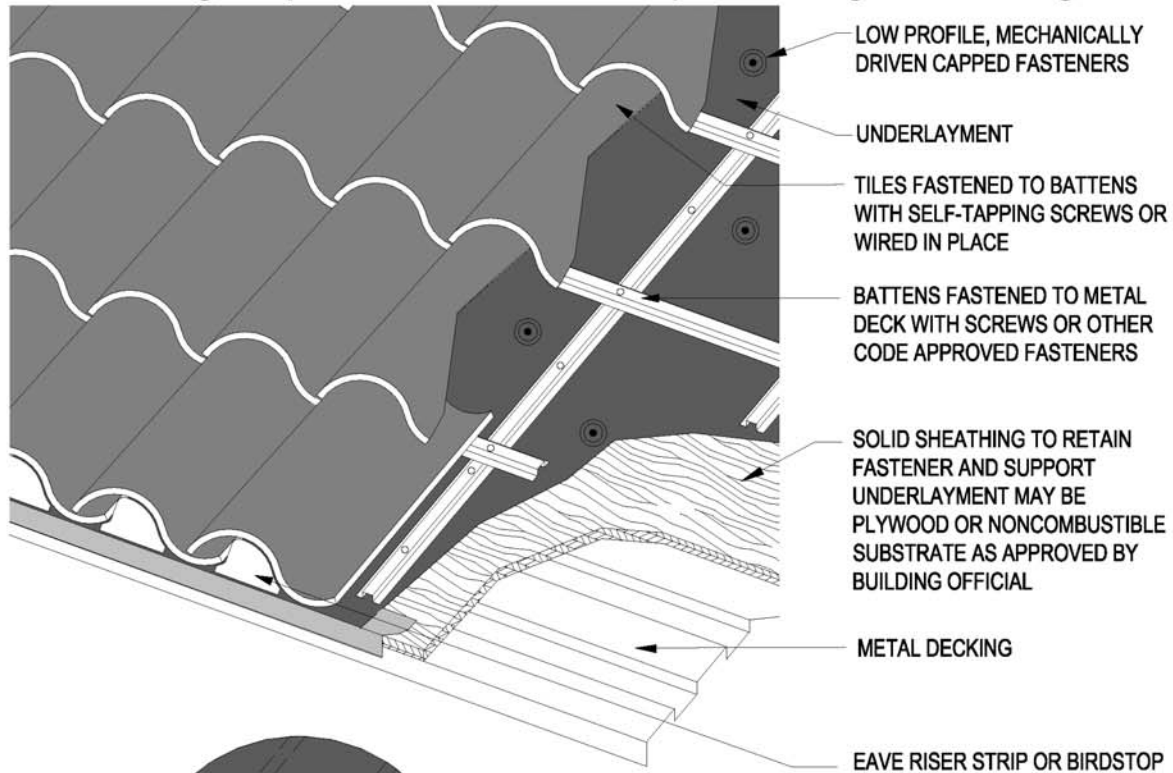
Installation on Metal Deck - Optional Considerations
Ribs Running Perpendicular To Roof Slope With Rigid Sheathing

FOR FIRE-RATED SYSTEMS,
ADDITIONAL COMPONENTS MAY
BE REQUIRED.

The pre-engineered roof systems are included for informational purposes only and are not recognized under evaluation reports for roof tiles.

Notes:

1. Vertical battens to be metal or as approved or designed as per metal deck manufacturer.
2. For recommended underlayment and fastening requirement, see Table 1A and 1B.
3. A sheet metal grip edge flashing is required with: stucco fascia, EIFS (Exterior Insulated Finish System) and flush fascia perimeter edges.
4. The fasteners must penetrate a minimum of 3/4" into dimensional wood decking or pass through wood panel sheathing which ever is less.
5. Eave closure should be of height equal to combined thickness of batten system and thickness of one course of tile.
6. On Type I (Non-Combustible) building all components must be fire-resistant as approved by local building officials.
7. Dimensions shown are recommended minimums and are intended to be approximate to allow for reasonable tolerances due to field conditions.

Drawing shown depicts the application of all tile profiles. Unless otherwise noted it would apply to either concrete or clay tiles.

SPECIALTY CONDITIONS - PRE-ENGINEERED ROOF

MC-25B

Installation on Metal Deck - Optional Considerations Ribs Running Perpendicular To Roof Slope

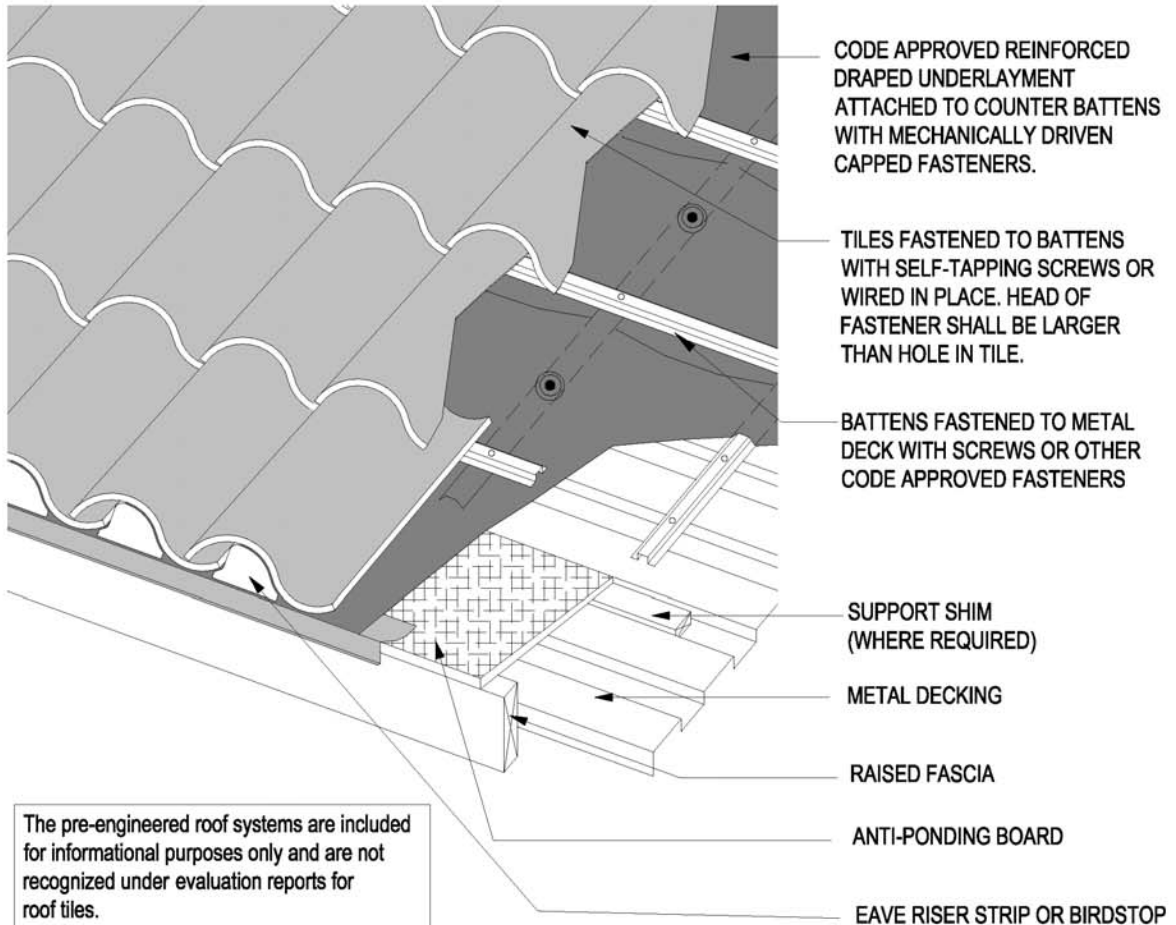

The pre-engineered roof systems are included for informational purposes only and are not recognized under evaluation reports for roof tiles.

FOR FIRE-RATED SYSTEMS, ADDITIONAL COMPONENTS MAY BE REQUIRED.

Notes:

1. Vertical battens to be metal or as approved or designed as per metal deck manufacturer.
2. For recommended underlayment and fastening requirement, see Table 1A and 1B.
3. A sheet metal grip edge flashing is required with: stucco fascia, EIFS (Exterior Insulated Finish System) and flush fascia perimeter edges.
4. Eave closure should be of height equal to combined thickness of batten system and thickness of one course of tile.
5. On Type I (Non-Combustible) building all components must be fire-resistant as approved by local building officials.
6. Dimensions shown are minimums and are intended to be approximate to allow for reasonable tolerances due to field conditions.

Drawing shown depicts the application of all tile profiles. Unless otherwise noted it would apply to either concrete or clay tiles.

SPECIALTY CONDITIONS - PRE-ENGINEERED ROOF

MC-25C

Installation on Metal Deck - Optional Considerations
Adhesive Based Systems - Solid Sheathing

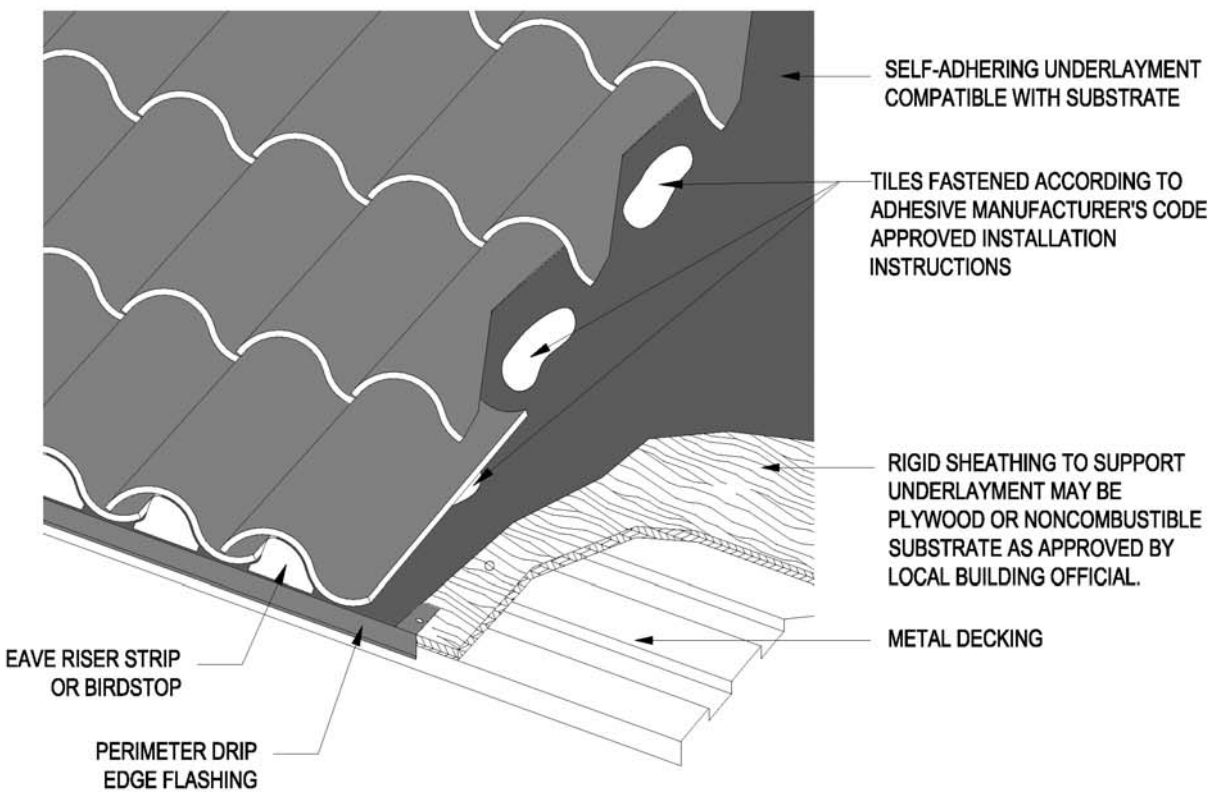

Note: Adhesion of underlayment to substrate shall be in accordance with assemblies recognized in a current ICC-ES evaluation report for roof tile adhesives evaluated to the requirements of AC-152.

The pre-engineered roof system are included for informational purposes only and are not recognized under evaluation reports for roof tiles.

- Notes:
1. On Type I (Non-Combustible) building all components must be fire-resistant as approved by local building officials.
 2. Dimensions shown are recommended minimums and are intended to be approximate to allow for reasonable tolerances due to field conditions.

Drawing shown depicts the application of all tile profiles. Unless otherwise noted it would apply to either concrete or clay tiles.

SPECIALTY CONDITIONS - PRE-ENGINEERED DECK

MC-26

Installation on Concrete Deck Considerations Adhesive Based Systems - On Counter Batten

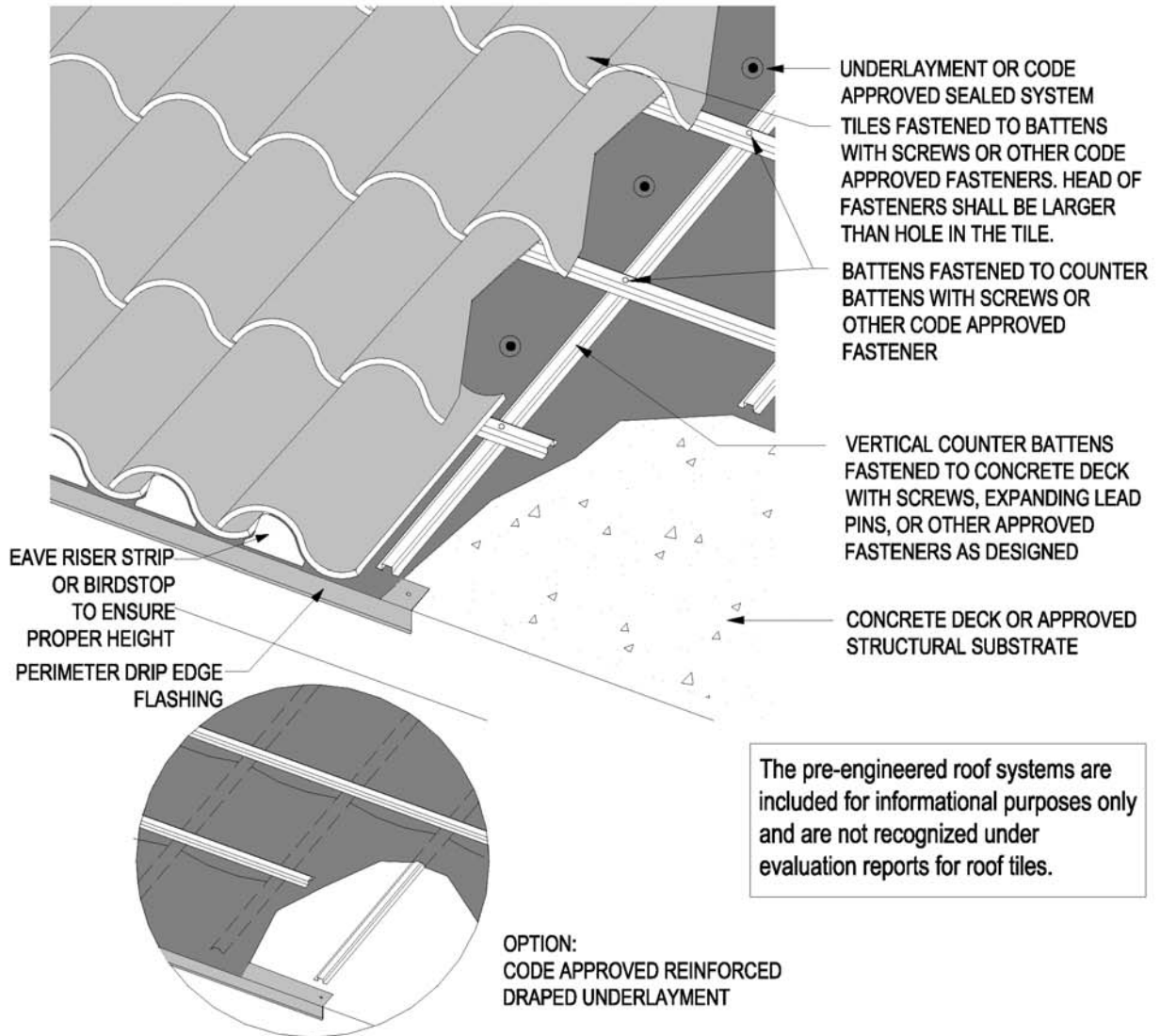

Notes:

1. Vertical battens to be metal or as approved or designed as per metal deck manufacturer.
2. Dimensions shown are minimums and are intended to be approximate to allow for reasonable tolerances due to field conditions.

Drawing shown depicts the application of all tile profiles. Unless otherwise noted it would apply to either concrete or clay tiles.

SPECIALTY CONDITIONS - PRE-ENGINEERED DECK

MC-26A

Installation on Concrete Deck Considerations
Adhesive based systems - Direct to Deck

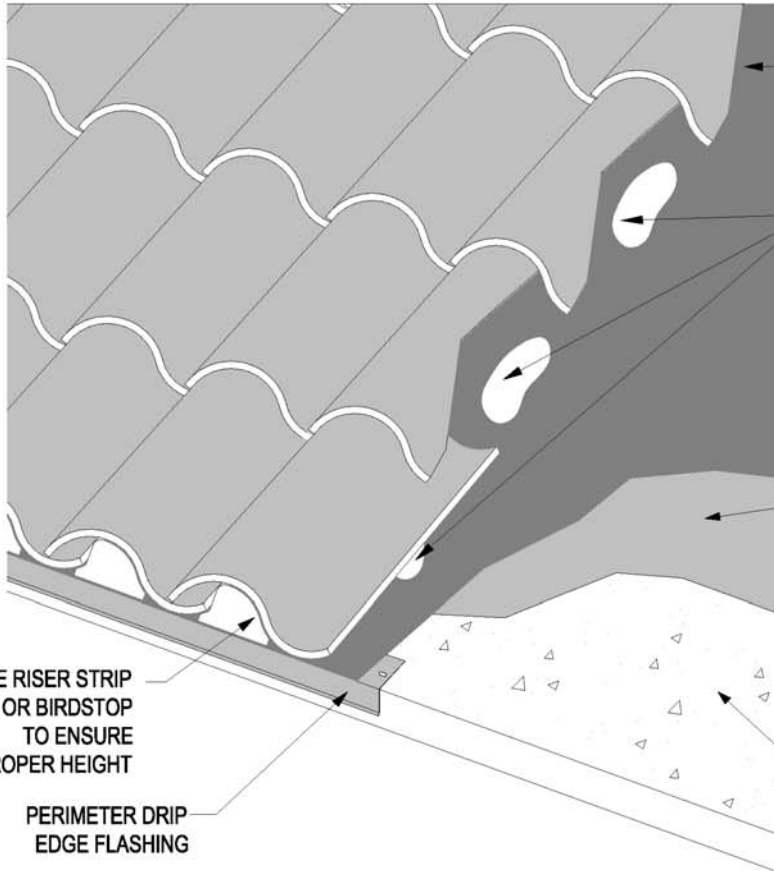

SELF-ADHERED UNDERLAYMENT OR CODE APPROVED SEALED SYSTEM COMPATIBLE WITH ROOF TILE ADHESIVE

TILES FASTENED ACCORDING TO ADHESIVE MANUFACTURER'S CODE APPROVED INSTALLATION INSTRUCTIONS

PRIMER WHERE REQUIRED FOR SELF-ADHERED UNDERLAYMENT APPLICATIONS REFER TO UNDERLAYMENT MANUFACTURERS CODE APPROVED INSTALLATION INSTRUCTIONS

CONCRETE DECK OR APPROVED STRUCTURAL SUBSTRATE

EAVE RISER STRIP OR BIRDSTOP TO ENSURE PROPER HEIGHT

PERIMETER DRIP EDGE FLASHING

Note: Adhesion of underlayment to substrate shall be in accordance with assemblies recognized in a current ICC-ES evaluation report for roof tile adhesives evaluated to the requirements of AC-152.

The pre-engineered roof systems are included for informational purposes only and are not recognized under evaluation reports for roof tiles.

Notes:

- 1. Dimensions shown are minimums and are intended to be approximate to allow for reasonable tolerances due to field conditions.

Drawing shown depicts the application of all tile profiles. Unless otherwise noted it would apply to either concrete or clay tiles.

Appendix A

SPECIALTY CONDITIONS - PRE-ENGINEERED ROOF SYSTEM

MC-27

Wire Attachment System On S-Tile

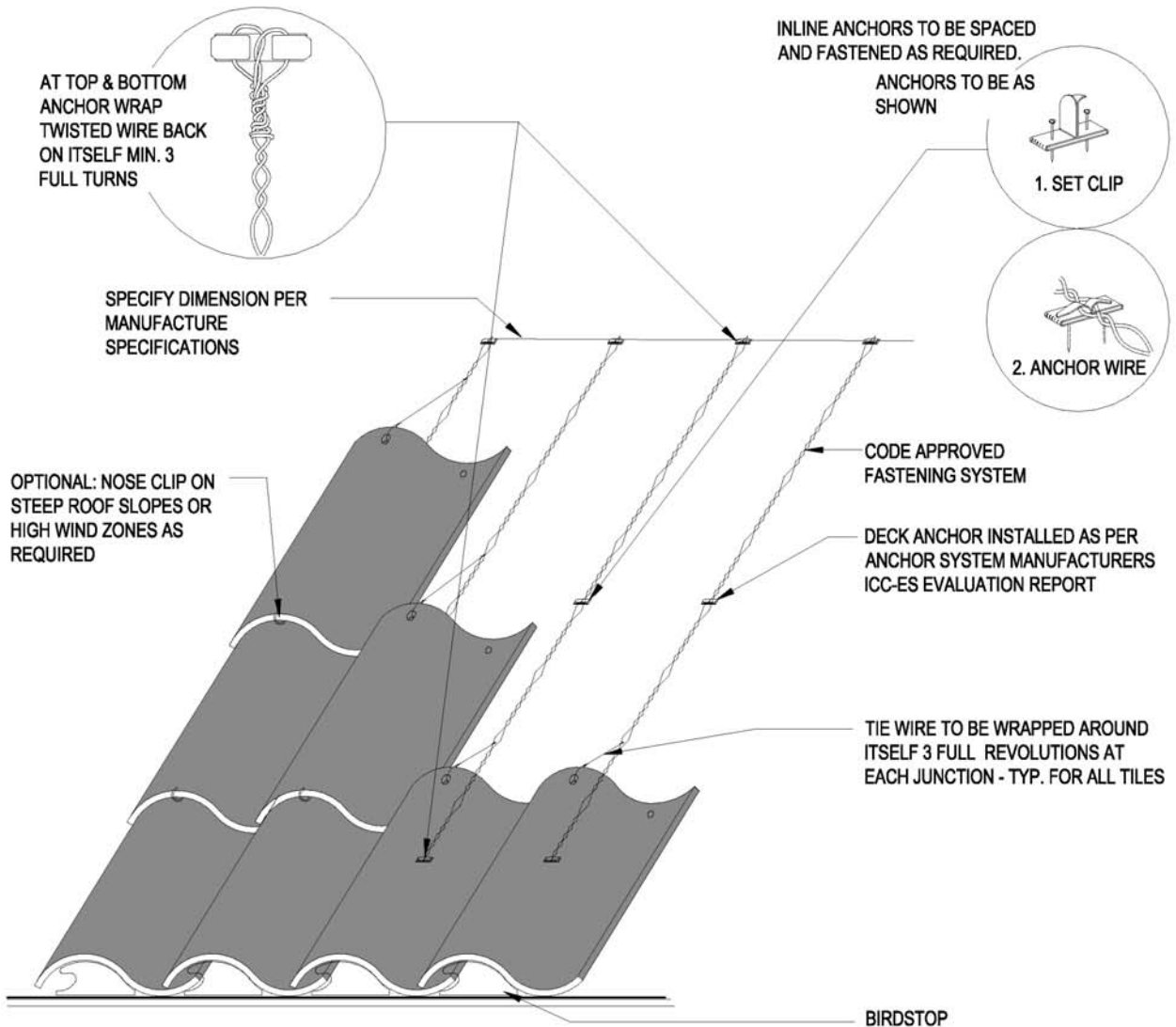

The pre-engineered roof systems are included for information purposes only and are not recognized under evaluation reports for roof tiles.

Drawing shown depicts the application of all tile profiles. Unless otherwise noted it would apply to either concrete or clay tiles.

SPECIALTY CONDITIONS - PRE-ENGINEERED ROOF SYSTEM

Wire Attachment System - For Cap And Pan Tile

MC-27A

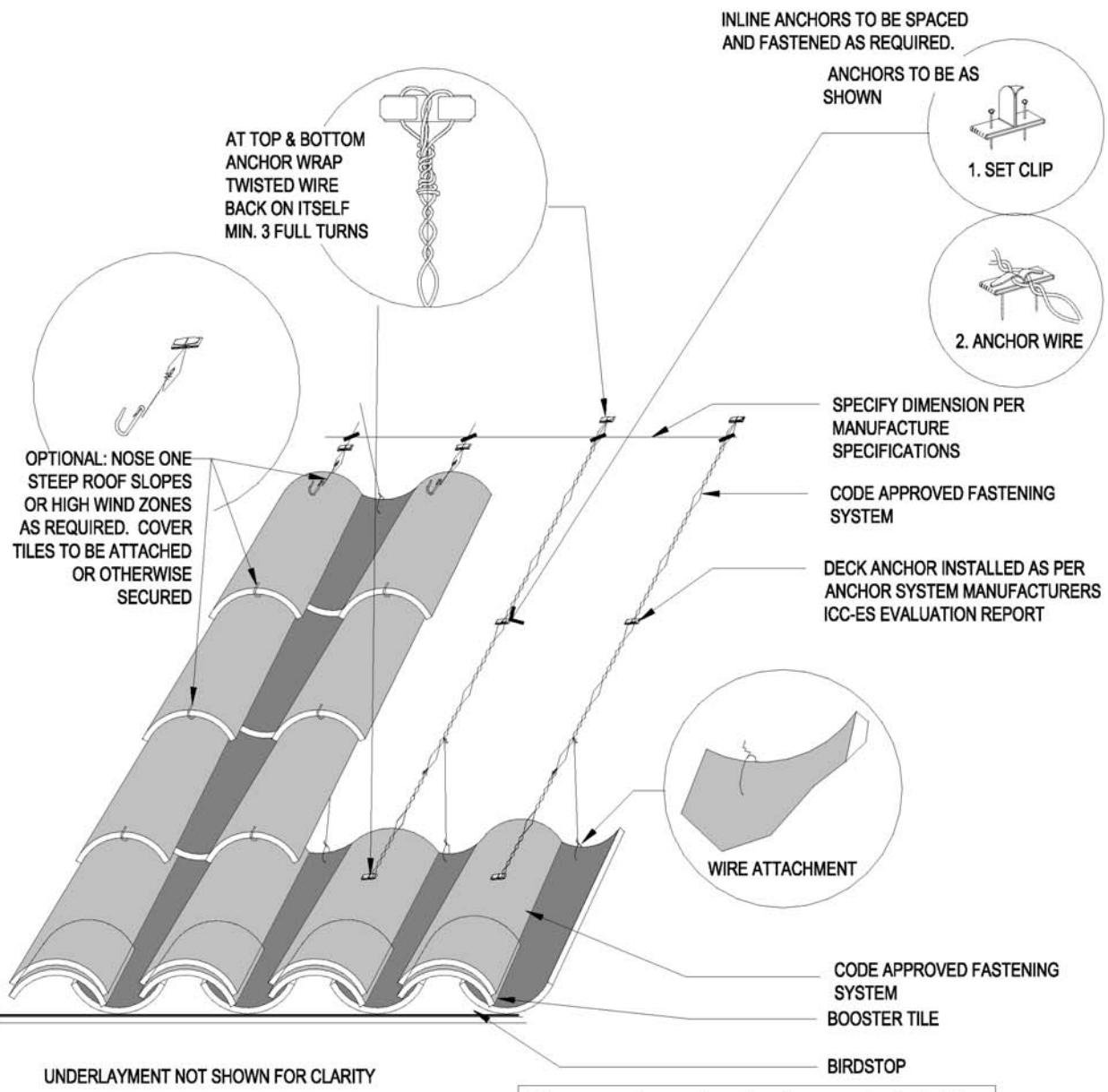

The pre-engineered roof systems are included for information purposes only and are not recognized under evaluation reports for roof tiles.

Drawing shown depicts the application of all tile profiles. Unless otherwise noted it would apply to either concrete or clay tiles.

SPECIALTY CONDITIONS

Nailer Installations - (Optional) for Cap and Pan

MC-27B

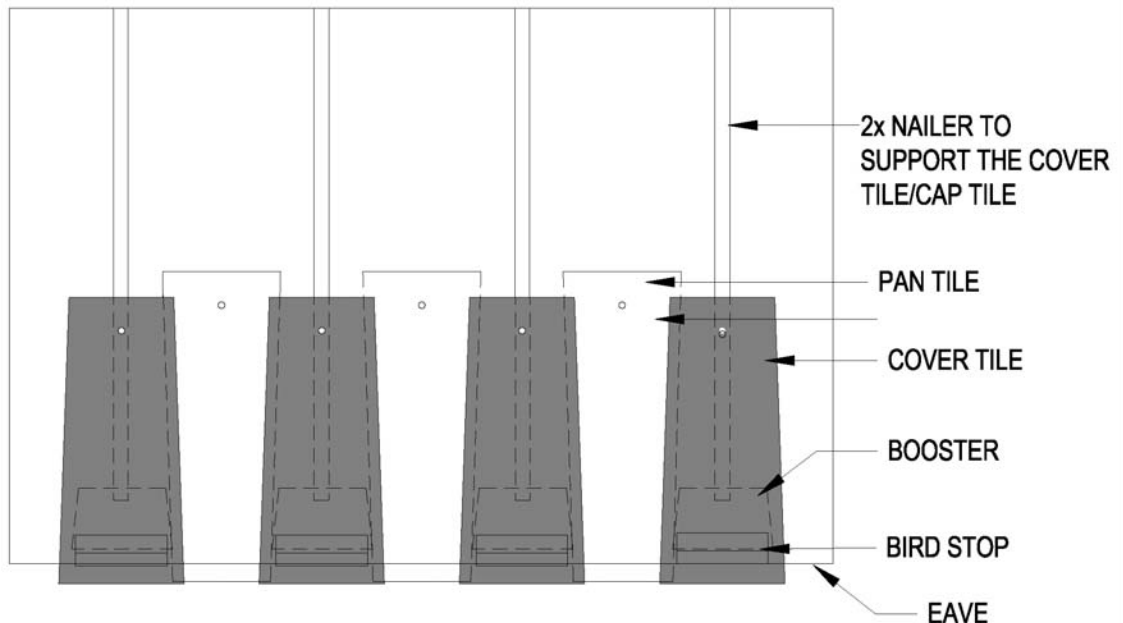
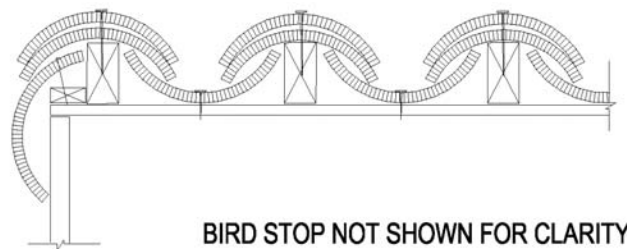
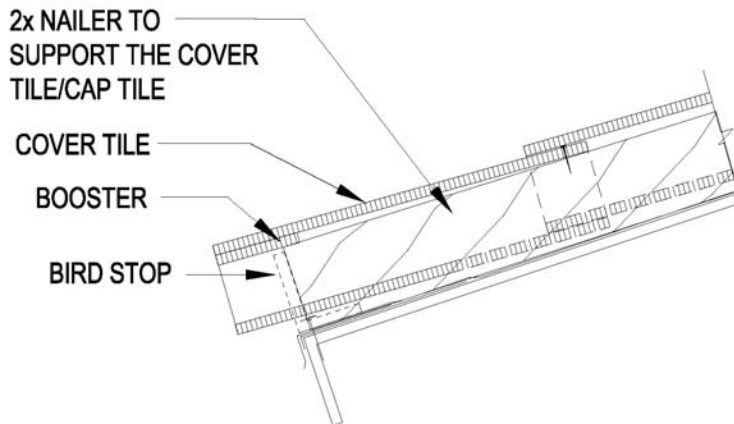

Appendix A

DRAPED UNDERLAYMENT APPLICATIONS

Underlayment applications under battens (e.g., sarking systems or open batten systems) that is recognized in a valid evaluation report for this use and approved by local building officials.

Two types of underlayment may be used in draped applications:

- Rolled underlayment (non-rigid)
- Rigid underlayment (rigid board)

INSTALLATION OF UNDERLAYMENT UNDER SPACED SHEATHING (Draped Underlayment)

ROLLED UNDERLAYMENT

A tapered antiponding board not less than 8" x 1/2" shall be nailed to the top of the fascia board to prevent the underlayment from sagging below the line of the fascia board.

The underlayment shall drape not less than 3/4" and no more than 1 1/2" between the trusses or rafters.

The underlayment shall be laid over the ridge to provide 6" laps in each direction at ridges (providing a minimum 12" overlap).

The underlayment shall be laid over the hip to provide minimum 6" side laps in each direction at hips and shall be fastened at two adjacent trusses or rafters.

When ending a roll in the field or the truss or rafter, begin a new roll one full truss or rafter back creating 24" side lap and mechanically fix both end and starter rolls on a member.

At roof-to-wall and roof-to-curb intersections/abutments the underlayment shall be turned up not less than 6" and shall be fastened to the abutting wall.

A lining ply or sheet of underlayment shall be installed in the valley and extend not less than 24" on each side of the valley center line. Underlayment shall be laid from each adjacent roof side parallel with the fascia board, or downslope roof perimeter, and shall be brought to the valley centerline.

Vents and protrusions such as plumbing stacks shall be flashed or sealed at the underlayment layer with membrane compatible sealant to prevent water from passing into the attic space.

RIGID UNDERLAYMENT

Rigid underlayment shall be installed with the longest side horizontal, allowing a minimum 6" side lap on the trusses or rafters and a minimum 4" head lap.

At the eave the underlayment shall overhang not less than 3/4" and shall be protected by an approved self adhering membrane a minimum of 6" on both sides.

Where a fascia board is used, the underlayment shall be fastened to the top of the fascia board and the junction of the trusses or rafters at the fascia.

The underlayment shall lap ridges and hips a minimum 6" in each direction, providing a total 12" overlap. At hip locations fastened to an adjacent truss or rafter.

A lining ply or base sheet shall be installed in the valley and extend not less than 24" on each side of the valley center line. The head lap shall be a minimum of 4".

Vents and protrusions, such as plumbing stacks, shall be flashed or sealed at the underlayment layer with membrane compatible sealant to prevent water from passing into the attic space.

TILE BATTENS FOR SPACED SHEATHING

Tile battens for spaced sheathing shall be a minimum 1" x 4" nominal spruce/pine/fir (SPF) standard No. 2 or better grade, or structurally equal. Fasteners and other fastening devices shall be corrosion resistant with shanks a minimum No. 11 gauge diameter and of sufficient length to penetrate 3/4" into the truss or rafter.

ADHESIVE SECUREMENT SYSTEMS (WHEN USED AS AN ALTERNATIVE TO MECHANICAL FASTENING)

As an alternative to mechanical fastening of roof tiles, the use of foam adhesive securement systems that are approved by the authority having jurisdiction may be used.

The restrictions, if any, are found in the code approval or evaluation report and will address any special considerations for underlayment attachment climate restrictions and the required amount and placement of the foam adhesive materials to provide the code required uplift resistance when

installed on direct deck and batten applications for concrete and clay tile.

When deciding to use foam adhesives for the securement of tile, consideration must be made on the compatibility of the adhesive to the underlayment surface. Although most code approved foam adhesives bond well to a variety of products like smooth or granulated underlayments, metal, concrete, clay, wood, etc., typically, they do not adhere to polyethylene or silicon surfaced products.

Design Considerations For High Wind Applications Under The 2009 IBC And IRC (ASCE 7-05)

Please refer to Tile Manufacturer's valid and approved evaluation report for additional details.

The installation requirements provided in Table IA and IB provide the normal installation guidelines for concrete and clay tile to comply with the International Building Code (Section 1507.3.7). The installation of tile in the specific regions of the country that are identified by ASCE 7-05 as subjected to wind speeds in excess of 100 miles per hour, may be required to have additional fastening options not found in Tables IA and IB.

The Tile Roofing Institute has derived various uplift resistance values for nails, screws and adhesive fastening systems. Each of these methods of installation may have limiting factors depending upon wind speed, roof slope and roof height. Please consult with your tile supplier or design professional for additional information about these optional systems for those unique installations.

IRC: On buildings having a maximum mean roof height of 40 feet (12.2m), tile application must comply with IRC section R905.3.7. For higher basic wind speeds or mean roof heights, installation must be in compliance with IBC Sections 1507.3.7 & 1609.5.3.

The following design aids are provided to the roof designer for consideration in determining the required aerodynamic uplift moment for roof tiles for wind applications beyond the prescriptive requirements in the IBC or IRC. These tables were developed based on the requirements of IBC Section 1609.5.3 and ASCE 7-05. Buildings and other structures that represent a substantial hazard to human life in the event of failure are to be designed using an Importance Factor of 1.15 (See ASCE 7-05, Table 1-1 for more information).

Design of Attachment System:

Building is a low rise structure located in an Exposure B region where the basic wind speed is 140 mph (3-second gust). The building is a Category II structure. The mean roof height of the building is 30 feet. The roof is a gable roof with a roof slope of 3:12. The terrain around the building does not abruptly change so as to create any wind speedup effects due to channeling, or shielding. The building is not located on a hill, ridge, or escarpment that would cause the wind to speedup. The roof tiles will be flat/low profile concrete roof tile with a total tile length of 16-1/2" and an exposed width of 11". The roof tiles weigh 9 pounds each. The roof covering is installed on solid sheathing.

Example 1: Calculate the Required Aerodynamic Uplift Moment and the Allowable Aerodynamic Uplift Resistance from Table 7:

Velocity Pressure:

$$q_h = 0.00256 K_z K_{zt} K_d V^2 I \quad (\text{ASCE 7 - 6.5.10})$$

$$q_h = \text{velocity pressure elevation at height } z \text{ (psf)}$$

$$K_z = \text{velocity pressure exposure coefficient at height } z \quad (\text{ASCE 7 - Table 6-3})$$

$$K_z = 0.70$$

$$K_{zt} = \text{topographic factor} \quad (\text{ASCE 7 - Figure 6-4})$$

$$K_{zt} = 1.00$$

cont'd on page 78

cont'd from page 77

K_d = wind directionality factor (ASCE 7 - Table 6-4)

$$K_d = 0.85$$

V = basic wind speed (mph) (ASCE 7 - Figure 6-1)

$$V = 140 \text{ mph}$$

I = importance factor (ASCE 7 - Table 6-1)

$$I = 1.00$$

$$q_h = 0.00256 K_z K_{zt} K_d V^2 I = 0.00256 (0.70) (1.00) (0.85) (140 \text{ mph})^2 (1.00)$$

$$q_h = 29.85 \text{ psf}$$

Required Aerodynamic Uplift Moment:

$$M_a = q_h C_L b L L_a (1 - GC_p) \quad (\text{IBC} - \text{Eq. 16-33})$$

M_a = aerodynamic uplift moment (ft-lbf)

q_h = velocity pressure elevation at mean roof height h (psf)

$$q_h = 29.85 \text{ psf}$$

C_L = lift coefficient = 0.2 (IBC - Section 1609.5.3)

b = exposed width of roof tile (ft)

$$b = 11" \sim 0.917'$$

L = length of roof tile (ft)

$$L = 16\text{-}\frac{1}{2}" \sim 1.375'$$

L_a = moment arm for the roof tile = 0.76 L
(IBC - Section 1609.7.3)

$$L_a = 0.76 (16\text{-}\frac{1}{2}") = 12.54" \sim 1.045'$$

GC_p = product of external pressure coefficient and gust factor

$$GC_p = -2.6$$

Note: The external pressure coefficient for Zone 3 was selected to calculate the required aerodynamic uplift moment. The use of this external pressure coefficient is conservative for zones 1 and 2.

$$M_a = q_h C_L b L L_a (1 - GC_p) = (29.85 \text{ psf}) (0.2) (0.917') (1.375') (1.045') (1 - [-2.6])$$

$$M_a = 28.3 \text{ ft lbf}$$

Required Aerodynamic Uplift Resistance:

For a direct deck installation select a fastening system from Table 7, Allowable Aerodynamic Uplift Moments - Mechanical Fastening Systems that is equal to or greater than 28.3 ft-lbf in order to comply with the code, such as 2-10d ring shank nails or 1-#8 screw.

$$2\text{-}10\text{d ring shank nails} = 39.1 \text{ ft-lbf} \quad (\text{TRIG Manual} - \text{Table 7})$$

$$1\text{-}\#8 \text{ screw} = 39.1 \text{ ft-lbf} \quad (\text{TRIG Manual} - \text{Table 7})$$

Example 2: Determine the Required Aerodynamic Uplift Moment using Table 5 or Table 6 and Allowable Aerodynamic Uplift Resistance from Table 7:

The flat/low concrete roof tile is within the combined maximum tile length and maximum exposed width listed in Table 6E, Maximum Combination of Tile Length and Tile's Exposed Width. This roof tile may be designed using the appropriate Table 5 or Table 6.

Based on the exposure and the roof pitch the appropriate table is Table 5A, Exposure B - Required Aerodynamic Uplift Moment. Table 5A indicates that the required aerodynamic uplift moment for this roof covering, M_a , is 30.3 ft-lbf.

$$\text{Required aerodynamic uplift moment, } M_a = 30.3 \text{ ft lbf} \quad (\text{TRIG Manual} - \text{Table 5A})$$

Note: The difference between the M_a 's in Example 1 and Example 2 is in the tile factor. Table 5 and Table 6 are based on a tile factor of 1.407 ft³ while the actual tile factor for this roof tile is 1.318 ft³. (Tile Factor = $b L L_a = (0.917') (1.375') (1.045') = 1.318 \text{ ft}^3$).

Required Aerodynamic Uplift Resistance:

For a direct deck installation select a fastening system from Table 7A, Allowable Aerodynamic Uplift Moments - Mechanical Fastening Systems that is equal to or greater than 30.3 ft-lbf in order to comply with the code, such as 2-10d ring shank nails or 1-#8 screw.

$$2\text{-}10\text{d ring shank nails} = 39.1 \text{ ft-lbf} \quad (\text{TRIG Manual} - \text{Table 7})$$

$$1\text{-}\#8 \text{ screw} = 39.1 \text{ ft-lbf} \quad (\text{TRIG Manual} - \text{Table 7})$$

Example 3: Design the Roof Tile Installation for a Lightweight Roof Tile:

The roof tile installation is identical to the previous examples except that the roof tiles lightweight roof tiles weighing 5 pounds each.

The flat/low lightweight concrete roof tile is within the combined maximum tile length and maximum exposed width listed in Table 6E, Maximum Combination of Tile Length and Tile's Exposed Width. This roof tile may be designed using the appropriate Table 5 or Table 6.

Required Aerodynamic Uplift Moment:

Based on the exposure and the roof pitch the appropriate table is Table 5A, Exposure B - Required Aerodynamic Uplift Moment. Table 5A indicates that the required aerodynamic uplift moment for this roof covering, M_a , is 30.3 ft-lbf.

$$M_a = 30.3 \text{ ft lbf} \quad (\text{TRIG Manual} - \text{Table 5A})$$

cont'd on page 79

cont'd from page 78

Mechanical Attachment Resistance:

For a direct deck installation select a fastening system from Table 7, Allowable Aerodynamic Uplift Moments - Mechanical Fastening Systems select an attachment resistance that is equal to or greater than 30.3 ft-lbf. Use 1-#8 screw which has a resistance of 39.1 ft-lbf.

$$1\text{-}\#8 \text{ screw} = 39.1 \text{ ft-lbf} \quad (\text{TRI Manual - Table 7})$$

Attachment Resistance:

Determine the attachment resistance with the generic restoring gravity moment used in Table 7. Footnote 10 for Table 7 states that the table is based on a generic restoring gravity moment of 6.5 ft-lbf for a direct deck installation and 5.5 ft-lbf for a batten installation. Based on a direct deck installation the attachment resistance for 1-#8 screw is 32.6 ft-lbf.

$$M_f = 39.1 \text{ ft-lbf} - 6.5 \text{ ft-lbf} = 32.6 \text{ ft-lbf}$$

Restoring Gravity Moment:

From Table 6F the restoring gravity moment for a roof tile weighing 5 lbm is 3.17 ft-lbf

$$M_g = 3.17 \text{ ft-lbf} \quad (\text{TRI Manual - Table 6F})$$

Allowable Aerodynamic Uplift Resistance:

The allowable aerodynamic uplift resistance for the flat/low lightweight concrete roof tile is the sum of the attachment resistance plus the restoring gravity moment for the flat/low lightweight concrete roof tile.

$$\text{Allowable Aerodynamic Uplift Resistance, } M_{all} = M_f + M_g = 32.6 \text{ ft-lbf} + 3.17 \text{ ft-lbf} = 35.77 \text{ ft-lbf}$$

$$M_{all} = 35.8 \text{ ft-lbf} > M_a = 30.3 \text{ ft lbf}$$

The use of 1-#8 screw to install each lightweight roof tile complies with the code for uplift resistance.

**TABLE 5A
Exposure B (ASCE 7-05)
Required Aerodynamic Uplift Moment¹**

Required Aerodynamic Uplift Moment, M_a (ft-lbf) Exposure B Gable Roof 2 1/2:12 < θ < 6:12 ($12^\circ < \theta < 27^\circ$) Hip Roof 5 1/2:12 < θ < 6:12 ($25^\circ < \theta < 27^\circ$)												
Mean Roof Height (ft)	Basic Wind Speed, V (mph)											
	85	90	100	105	110	120	125	130	140	145	150	170
Importance Factor = 1.00												
0-30	11.2	12.5	15.4	17.0	18.7	22.2	24.1	26.1	30.3	32.5	34.7	44.6
40	12.1	13.6	16.8	18.5	20.3	24.1	26.2	28.3	32.9	35.3	37.7	48.5
50	12.9	14.5	17.9	19.7	21.6	25.7	27.9	30.2	35.0	37.6	40.2	51.6
60	13.6	15.2	18.8	20.8	22.8	27.1	29.4	31.8	36.9	39.6	42.4	54.4
Importance Factor = 1.15												
0-30	12.8	14.4	17.8	19.6	21.5	25.6	27.7	30.0	34.8	37.3	40.0	51.3
40	13.9	15.6	19.3	21.3	23.3	27.8	30.1	32.6	37.8	40.5	43.4	55.7
50	14.8	16.6	20.6	22.7	24.9	29.6	32.1	34.7	40.3	43.2	46.2	59.4
60	15.6	17.5	21.6	23.9	26.2	31.2	33.8	36.6	42.4	45.5	48.7	62.6

Appendix B

TABLE 5B
Exposure B (ASCE 7-05)
Required Aerodynamic Uplift Moment¹

Required Aerodynamic Uplift Moment, M_a (ft-lbf) Exposure B Hip Roof 2 1/2:12 < θ < 5 1/2:12 ($12^\circ < \theta < 25^\circ$)												
Mean Roof Height (ft)	Basic Wind Speed, V (mph)											
	85	90	100	105	110	120	125	130	140	145	150	170
Importance Factor = 1.00												
0-30	8.4	9.4	11.6	12.8	14.0	16.7	18.1	19.6	22.7	24.4	26.1	33.5
40	9.1	10.2	12.6	13.9	15.2	18.1	19.6	21.3	24.6	26.4	28.3	36.3
50	9.7	10.9	13.4	14.8	16.2	19.3	20.9	22.6	26.3	28.2	30.2	38.7
60	10.2	11.4	14.1	15.6	17.1	20.3	22.1	23.9	27.7	29.7	31.8	40.8
Importance Factor = 1.15												
0-30	9.6	10.8	13.3	14.7	16.1	19.2	20.8	22.5	26.1	28.0	30.0	38.5
40	10.4	11.7	14.5	15.9	17.5	20.8	22.6	24.4	28.3	30.4	32.5	41.8
50	11.1	12.5	15.4	17.0	18.6	22.2	24.1	26.0	30.2	32.4	34.7	44.5
60	11.7	13.2	16.2	17.9	19.6	23.4	25.4	27.4	31.8	34.1	36.5	46.9

TABLE 5C
Exposure B (ASCE 7-05)
Required Aerodynamic Uplift Moment¹

Required Aerodynamic Uplift Moment, M_a (ft-lbf) Exposure B Gable Roof 6:12 < θ < 12:12 ($27^\circ < \theta < 45^\circ$)												
Mean Roof Height (ft)	Basic Wind Speed, V (mph)											
	85	90	100	105	110	120	125	130	140	145	150	170
Importance Factor = 1.00												
0-30	6.8	7.6	9.4	10.4	11.4	13.6	14.7	15.9	18.5	19.8	21.2	27.3
40	7.4	8.3	10.2	11.3	12.4	14.8	16.0	17.3	20.1	21.5	23.1	29.6
50	7.9	8.8	10.9	12.0	13.2	15.7	17.1	18.5	21.4	23.0	24.6	31.6
60	8.3	9.3	11.5	12.7	13.9	16.6	18.0	19.4	22.5	24.2	25.9	33.2
Importance Factor = 1.15												
0-30	7.8	8.8	10.9	12.0	13.1	15.6	17.0	18.3	21.3	22.8	24.4	31.4
40	8.5	9.5	11.8	13.0	14.3	17.0	18.4	19.9	23.1	24.8	26.5	34.1
50	9.1	10.2	12.6	13.8	15.2	18.1	19.6	21.2	24.6	26.4	28.3	36.3
60	9.6	10.7	13.2	14.6	16.0	19.1	20.7	22.4	25.9	27.8	29.8	38.2

TABLE 5D
Exposure B (ASCE 7-05)
Required Aerodynamic Uplift Moment¹

Required Aerodynamic Uplift Moment, M_a (ft-lbf)												
Exposure B												
Monoslope Roof $2\frac{1}{2}:12 < \theta < 6\frac{3}{4}:12$ ($12^\circ < \theta < 30^\circ$)												
Mean Roof Height (ft)	Basic Wind Speed, V (mph)											
	85	90	100	105	110	120	125	130	140	145	150	170
Importance Factor = 1.00												
0-30	12.1	13.6	16.7	18.4	20.2	24.1	26.1	28.3	32.8	35.2	37.6	48.3
40	13.1	14.7	18.2	20.0	22.0	26.2	28.4	30.7	35.6	38.2	40.9	52.5
50	14.0	15.7	19.4	21.3	23.4	27.9	30.2	32.7	37.9	40.7	43.6	55.9
60	14.7	16.5	20.4	22.5	24.7	29.4	31.9	34.5	40.0	42.9	45.9	58.9
Importance Factor = 1.15												
0-30	13.9	15.6	19.2	21.2	23.3	27.7	30.1	32.5	37.7	40.5	43.3	55.6
40	15.1	16.9	20.9	23.0	25.3	30.1	32.6	35.3	40.9	43.9	47.0	60.4
50	16.1	18.0	22.3	24.5	26.9	32.1	34.8	37.6	43.6	46.8	50.1	64.3
60	16.9	19.0	23.5	25.9	28.4	33.8	36.6	39.6	46.0	49.3	52.8	67.8

TABLE 6A
Exposure C (ASCE 7-05)
Required Aerodynamic Uplift Moment¹

Required Aerodynamic Uplift Moment, M_a (ft-lbf)												
Exposure C												
Gable Roof $2\frac{1}{2}:12 < \theta < 6:12$ ($12^\circ < \theta < 27^\circ$)												
Hip Roof $5\frac{1}{2}:12 < \theta < 6:12$ ($25^\circ < \theta < 27^\circ$)												
Mean Roof Height (ft)	Basic Wind Speed, V (mph)											
	85	90	100	105	110	120	125	130	140	145	150	170
Importance Factor = 1.00												
0-15	13.5	15.2	18.7	20.6	22.6	26.9	29.2	31.6	36.7	39.3	42.1	54.1
20	14.4	16.1	19.9	21.9	24.1	28.6	31.1	33.6	39.0	41.8	44.7	57.5
25	15.1	16.9	20.8	23.0	25.2	30.0	32.6	35.2	40.8	43.8	46.9	60.2
30	15.6	17.5	21.7	23.9	26.2	31.2	33.8	36.6	42.4	45.5	48.7	62.6
40	16.6	18.6	23.0	25.4	27.8	33.1	35.9	38.9	45.1	48.4	51.8	66.5
50	17.4	19.5	24.1	26.6	29.2	34.7	37.7	40.7	47.3	50.7	54.2	69.7
60	18.1	20.3	25.1	27.6	30.3	36.1	39.1	42.3	49.1	52.7	56.4	72.4
Importance Factor = 1.15												
0-15	15.5	17.4	21.5	23.7	26.0	31.0	33.6	36.4	42.2	45.2	48.4	62.2
20	16.5	18.5	22.9	25.2	27.7	32.9	35.7	38.6	44.8	48.1	51.4	66.1
25	17.3	19.4	24.0	26.4	29.0	34.5	37.4	40.5	47.0	50.4	53.9	69.2
30	18.0	20.2	24.9	27.5	30.1	35.9	38.9	42.1	48.8	52.4	56.0	72.0
40	19.1	21.4	26.5	29.2	32.0	38.1	41.3	44.7	51.8	55.6	59.5	76.5
50	20.0	22.5	27.7	30.6	33.5	39.9	43.3	46.9	54.3	58.3	62.4	80.1
60	20.8	23.3	28.8	31.8	34.9	41.5	45.0	48.7	56.5	60.6	64.8	83.3

TABLE 6B
Exposure C (ASCE 7-05)
Required Aerodynamic Uplift Moment¹

Required Aerodynamic Uplift Moment, M_a (ft-lbf)												
Exposure C												
Hip Roof 2 1/2:12 < θ < 6:12 ($12^\circ < \theta < 27^\circ$)												
Mean Roof Height (ft)	Basic Wind Speed, V (mph)											
	85	90	100	105	110	120	125	130	140	145	150	170
Importance Factor = 1.00												
0-15	10.1	11.4	14.0	15.5	17.0	20.2	21.9	23.7	27.5	29.5	31.6	40.6
20	10.8	12.1	14.9	16.4	18.0	21.5	23.3	25.2	29.2	31.3	33.5	43.1
25	11.3	12.7	15.6	17.2	18.9	22.5	24.4	26.4	30.6	32.9	35.2	45.2
30	11.7	13.2	16.2	17.9	19.6	23.4	25.4	27.4	31.8	34.1	36.5	46.9
40	12.5	14.0	17.3	19.0	20.9	24.8	27.0	29.2	33.8	36.3	38.8	49.9
50	13.1	14.6	18.1	19.9	21.9	26.0	28.3	30.6	35.4	38.0	40.7	52.3
60	13.6	15.2	18.8	20.7	22.7	27.1	29.4	31.8	36.8	39.5	42.3	54.3
Importance Factor = 1.15												
0-15	11.7	13.1	16.1	17.8	19.5	23.2	25.2	27.3	31.6	33.9	36.3	46.6
20	12.4	13.9	17.1	18.9	20.7	24.7	26.8	29.0	33.6	36.1	38.6	49.6
25	13.0	14.6	18.0	19.8	21.7	25.9	28.1	30.4	35.2	37.8	40.4	51.9
30	13.5	15.1	18.7	20.6	22.6	26.9	29.2	31.6	36.6	39.3	42.0	54.0
40	14.3	16.1	19.8	21.9	24.0	28.6	31.0	33.5	38.9	41.7	44.6	57.3
50	15.0	16.8	20.8	22.9	25.2	29.9	32.5	35.1	40.8	43.7	46.8	60.1
60	15.6	17.5	21.6	23.8	26.1	31.1	33.8	36.5	42.4	45.4	48.6	62.4

TABLE 6C
Exposure C (ASCE 7-05)
Required Aerodynamic Uplift Moment¹

Required Aerodynamic Uplift Moment, M_a (ft-lbf)												
Exposure C												
Gable Roof 6:12 < θ < 12:12 ($27^\circ < \theta < 45^\circ$)												
Mean Roof Height (ft)	Basic Wind Speed, V (mph)											
	85	90	100	105	110	120	125	130	140	145	150	170
Importance Factor = 1.00												
0-15	8.3	9.3	11.4	12.6	13.8	16.5	17.9	19.3	22.4	24.0	25.7	33.0
20	8.8	9.8	12.1	13.4	14.7	17.5	19.0	20.5	23.8	25.5	27.3	35.1
25	9.2	10.3	12.7	14.0	15.4	18.3	19.9	21.5	25.0	26.8	28.6	36.8
30	9.6	10.7	13.2	14.6	16.0	19.1	20.7	22.4	25.9	27.8	29.8	38.2
40	10.2	11.4	14.1	15.5	17.0	20.2	22.0	23.8	27.6	29.6	31.6	40.6
50	10.6	11.9	14.7	16.2	17.8	21.2	23.0	24.9	28.9	31.0	33.2	42.6
60	11.1	12.4	15.3	16.9	18.5	22.0	23.9	25.9	30.0	32.2	34.4	44.2
Importance Factor = 1.15												
0-15	9.5	10.7	13.2	14.5	15.9	18.9	20.5	22.2	25.8	27.6	29.6	38.0
20	10.1	11.3	14.0	15.4	16.9	20.1	21.8	23.6	27.4	29.4	31.4	40.4
25	10.6	11.9	14.6	16.1	17.7	21.1	22.9	24.7	28.7	30.8	32.9	42.3
30	11.0	12.3	15.2	16.8	18.4	21.9	23.8	25.7	29.8	32.0	34.2	44.0
40	11.7	13.1	16.2	17.8	19.6	23.3	25.3	27.3	31.7	34.0	36.4	46.7
50	12.2	13.7	16.9	18.7	20.5	24.4	26.5	28.6	33.2	35.6	38.1	49.0
60	12.7	14.3	17.6	19.4	21.3	25.4	27.5	29.8	34.5	37.0	39.6	50.9

TABLE 6D
Exposure C (ASCE 7-05)
Required Aerodynamic Uplift Moment¹

Required Aerodynamic Uplift Moment, M_a (ft-lbf) Exposure C Monoslope Roof $2\frac{1}{2}:12 < \theta < 6\frac{3}{4}:12$ ($12^\circ < \theta < 30^\circ$)												
Mean Roof Height (ft)	Basic Wind Speed, V (mph)											
	85	90	100	105	110	120	125	130	140	145	150	170
Importance Factor = 1.00												
0-15	14.6	16.4	20.3	22.3	24.5	29.2	31.7	34.3	39.7	42.6	45.6	58.6
20	15.6	17.4	21.5	23.7	26.1	31.0	33.7	36.4	42.2	45.3	48.5	62.2
25	16.3	18.3	22.6	24.9	27.3	32.5	35.3	38.1	44.2	47.5	50.8	65.2
30	16.9	19.0	23.5	25.9	28.4	33.8	36.6	39.6	46.0	49.3	52.8	67.8
40	18.0	20.2	24.9	27.5	30.2	35.9	38.9	42.1	48.8	52.4	56.1	72.0
50	18.9	21.2	26.1	28.8	31.6	37.6	40.8	44.1	51.2	54.9	58.8	75.5
60	19.6	22.0	27.1	29.9	32.8	39.1	42.4	45.9	53.2	57.1	61.1	78.4
Importance Factor = 1.15												
0-15	16.8	18.9	23.3	25.7	28.2	33.6	36.4	39.4	45.7	49.0	52.5	67.4
20	17.9	20.1	24.8	27.3	30.0	35.7	38.7	41.9	48.5	52.1	55.7	71.6
25	18.8	21.0	26.0	28.6	31.4	37.4	40.6	43.9	50.9	54.6	58.4	75.0
30	19.5	21.8	27.0	29.7	32.6	38.8	42.1	45.6	52.9	56.7	60.7	78.0
40	20.7	23.2	28.7	31.6	34.7	41.3	44.8	48.4	56.2	60.3	64.5	82.8
50	21.7	24.3	30.0	33.1	36.3	43.3	46.9	50.8	58.9	63.2	67.6	86.8
60	22.6	25.3	31.2	34.4	37.8	44.9	48.8	52.7	61.2	65.6	70.2	90.2

TABLE 6E
Maximum Dimensions to Satisfy Tile Factor of 1.407 ft³ (ASCE 7-05)

Maximum Combination of Tile Length and Tile's Exposed Width										
Maximum Tile Length (inches)	20	18-½	18	17-½	16-½	16	15-½	15	14-½	14
Maximum Exposed Width (inches)	8	9-¼	9-¾	10-¼	11-¾	12-½	13-¼	14	15	15

TABLE 6F
Restoring Gravity Moment (ASCE 7-05)

Maximum Combination of Tile Length and Tile's Exposed Width						
Tile Weight (lbs)	5	6	7	8	9	10
M_g (ft-lbft)	3.17	3.80	4.43	5.06	5.7	6.33

Notes for Tables 5A through 6F:

- I. Roof tiles shall comply with the following dimensions:
 - (1) The total length of the roof tile shall be between 1.0 foot and 1.75 feet.
 - (2) The exposed width of the roof tile shall be between 0.67 feet and 1.25 feet.
 - (3) The maximum thickness of the tail of the roof tile shall not exceed 1.3 inches.

Notes cont'd from page 83

2. The required aerodynamic uplift moments in these tables are based on a roof tile that has a Tile Factor of 1.407 ft³. The required aerodynamic uplift moment for roof tiles with a Tile Factor other than 1.407 ft³ may be determined by using the following procedure. These tables are conservative for roof tiles with a Tile Factor less than 1.407 ft³.

(1) Calculate the Tile Factor for the desired roof tile.

$$\text{Tile Factor} = b (L) (L_a)$$

b = exposed width of the roof tile (ft)

L = total length of roof tile (ft)

L_a = moment between point of rotation and the theoretical location of the resultant of the wind uplift force.

For the standard roof tiles the moment arm = 0.76 L (See IBC - Section 1609.7.3)

(2) Based on exposure, roof style, roof pitch, importance, basic wind speed, and mean roof height select the appropriate required aerodynamic uplift moment from the tables for the desired roof tile.

(3) Multiply the selected required aerodynamic uplift moment by the ratio of the tile factor for the desired roof tile and 1.407 ft³.

(4) Select an attachment system that is equal to or greater than the calculated required aerodynamic uplift moment in step 3.

3. Table 6E provides a combination of exposed widths and total lengths that generate a Tile Factor of 1.407 ft³. The table "Maximum Combination of Tile Length and Tile's Exposed Width" provides a listing of tiles that fit this Tile Factor.

TABLE 7
Allowable Aerodynamic Uplift Moments
Mechanical Fastening Systems

Direct Deck Installation		
Roof Tile Profiler	15/32" Sheathing (plywood or code approved equivalent)	Allowable Aerodynamic Uplift Resistance (ft-lbf)
Flat/Low Medium High	2-10d ring shank nails (18-22 rings per inch)	39.1 36.1 28.6
Flat/Low Medium High	1-#8 screw	39.1 33.3 28.7
Flat/Low Medium High	2-#8 screws	50.1 55.5 51.3
Flat/Low Medium High	1-10d smooth or screw shank nail	13.5 12.9 11.3
Flat/Low Medium High	2-10d smooth or screw shank nails	20.2 19.1 13.1
Flat/Low Medium High	1-10d smooth or screw shank nail with clip	25.2 25.2 35.5
Flat/Low Medium High	2-10d smooth or screw shank nail with clip	38.1 38.1 44.3

TABLE 7 (Cont'd)
Allowable Aerodynamic Uplift Moments
Mechanical Fastening Systems

Batten Installation		
Roof Tile Profiler	15/32" Sheathing (plywood or code approved equivalent)	Allowable Aerodynamic Uplift Resistance (ft-lbf)
Flat/Low Medium High	2-10d ring shank nails (18-22 rings per inch)	24.6 36.4 26.8
Flat/Low Medium High	1-#8 screw	25.6 30.1 25.5
Flat/Low Medium High	2-#8 screws	36.1 41.9 37.1
Flat/Low Medium High	1-10d smooth or screw shank nail	10.1 8.7 8.2
Flat/Low Medium High	2-10d smooth or screw shank nails	12.8 11.9 12.7
Flat/Low Medium High	1-10d smooth or screw shank nail with clip	27.5 27.5 29.4
Flat/Low Medium High	2-10d smooth or screw shank nail with clip	37.6 37.6 47.2
Direct Deck Installation		
Roof Tile Profiler	19/32" Sheathing (plywood or code approved equivalent)	Allowable Aerodynamic Uplift Resistance (ft-lbf)
Flat/Low Medium High	2-10d ring shank nails (18-22 rings per inch)	46.4 45.5 41.2
Flat/Low Medium High	1-10d smooth or screw shank nail	16.0 15.2 13.0
Flat/Low Medium High	2-10d smooth or screw shank nails	25.0 23.4 15.4

Notes for Table 7:

1. For attachment systems not listed in the table for 19/32" sheathing use the allowable aerodynamic uplift resistance from the table for 15/32" sheathing.
2. Fasteners shall have a minimum edge distance of 1-1/2 inches from the head of the tile and located in the pan of the tile to obtain the values in Table 7. Consult the tile manufacturer for additional limitations or restrictions.

Notes cont'd on page 86

Notes for Table 7(Cont'd):

3. Ring shank nails shall be 10d ring shank corrosion resistant steel nails with the following minimum dimensions: (3 inches long, 0.283 inch flat head diameter, 0.120 inch undeformed shank diameter or 0.131 inch screw diameter).
4. Smooth or screw shank nails shall be 10d corrosion resistant steel (with the following minimum dimension. 3 inch long, 0.283 inch flat head diameter, 0.120 inch undeformed shank diameter or 0.131 inch screw diameter).
5. Screws are #8 coarse threaded, 2.5 inches long corrosion-resistant steel wood screws conforming to ANSI/ASME B 18.6.1.
6. The fastener hole nearest the overlock shall be used when a single nail or screw is required. The fastener hole nearest the underlock and the fastener hole nearest the overlock shall be used when two nails or screws are required.
7. When using eave and field clips, attachment of the tiles is accomplished by a combination of nails and clips. Tiles are nailed to the sheathing or through the battens to the sheathing with one or two 10d corrosion resistant nails (Note 2 and 3 above) as required by Tables 5 and 6. Additionally, each tile is secured with a 0.060 inch thick and 0.5 inch wide clip which is secured to the plywood sheathing or eave fascia, as appropriate, with a single nail per clip. The nail shall be placed in the hole closest to the tile for clips having more than one nail hole. The following clip/nail combinations are permitted:
 - (1) Aluminum alloy clip with 1.25 inch HD galvanized roofing nail (0.128 inch shank diameter).
 - (2) Galvanized steel deck clip with 1.25 inch HD galvanized roofing nail (0.128 inch shank diameter).
 - (3) Stainless steel clip with 1.25 inch HD galvanized roofing nail (0.128 inch shank diameter).
8. Field clips and eave clips are to be located along the tile where the clip's preformed height and the tile's height above the underlayment are identical.
9. Counter batten values not included.
10. For attachment systems not listed in table for $19/32$ inch sheathing, use allowable aerodynamic uplift moment from table for $15/32$ inch sheathing.
11. The allowable aerodynamic uplift moments include a generic restoring gravity moment of 6.5 ft-lbf for a direct deck installation and a generic restoring gravity moment of 5.5 ft-lbf for a batten installation."

Additional Notes [outside the scope of Uniform ES ER-2015 or this manual]

**Allowable Aerodynamic Uplift Moments
Adhesive Fastening Systems**

Refer to the adhesive manufacturer for the allowable aerodynamic uplift moment for the installation method used to comply with the applicable code requirements. Installation of roof tiles using the adhesive system should be done by technicians trained and having a current certification by the adhesive manufacturer to comply with the applicable code requirements.

**Allowable Aerodynamic Uplift Moments
Mortar Fastening Systems**

Refer to the pre-bagged mortar mix manufacturer for the allowable aerodynamic uplift moment for the installation method used to comply with the applicable code requirements. Mixing of mortar at the jobsite is not a recommended practice. Installation of roof tiles using the mortar system should be done by technicians trained and having a current certification by the mortar mix manufacturer to comply with the applicable code requirements.

Design Considerations for Installations in Earthquake Regions

[Outside the scope of Uniform ES ER-2015 or this manual.]

The Tile Roofing Institute in conjunction with the University of Southern California, Structural Engineering Department conducted a series of testing on the Seismic Performance of Concrete and Clay Tile. The testing concluded that Concrete and Clay tile, when installed according to ICC code requirements, withstood forces almost twice the code requirements for structures.

Tile is the only roofing material to have conducted such testing on roof assemblies and is pleased to report that concrete and clay tile will not require any additional fastening requirements, other than those required under the current ICC code.

Design Considerations For High Wind Applications Under The 2012 IBC And IRC (ASCE 7-10)

Please Refer to Tile Manufacturer’s valid and approved Evaluation Report for additional wind design details.

The installation requirements provided in Table IA and IB provide the normal installation guidelines for concrete and clay tile to comply with the 2012 International Building Code (Section 1507.3.7). The installation of tile in the specific region of the country that are identified by IBC as subjected to wind speeds in excess of 110 miles per hour (V_{asd}), may be required to have additional fastening options not found in Tables IA or IB.

The Tile Roofing Institute has derived various uplift resistance values for nail, screws and adhesive fastening systems. Some of these methods of installation may have limiting factors depending upon wind speed, roof slope and roof height. Please consult with you tile supplier or design professional for additional information about these optional systems for

those unique installations.

On buildings located in areas where IRC wind speeds do not exceed 100 mph and having a maximum mean roof height of 40 feet (12.2 m), tile application must comply with 2012 IRC Section R905.3.7. For higher basic wind speeds or mean roof heights, installation must be in compliance with 2012 IBC Sections 1507.3.7 & 1609.5.3.

The following design aids are provided to the roof designer for consideration in determining the required aerodynamic uplift moment for roof tiles for wind applications beyond the prescriptive requirements in the IBC or IRC. These tables were developed based on the requirement of 2012 IBC Section 1609.5.3 and ASCE 7-10.

TABLE 8 (ASCE 7-10)

Conversion from Nominal Design Wind Speed to V_{asd} to Ultimate Design Wind Speed V_{ult} shall be converted as $V_{asd} = V_{ult} * \sqrt{0.6}$ or from the following table;

Design Wind Speed Conversion (mph)									
V_{ult}	110	120	130	140	150	160	170	180	190
V_{asd}	85	93	101	108	116	124	132	139	147

For SI: 1 mile per hour = 0.44 m/s A linear interpolation is permitted.

Design of Attachment System:

Example 1:

A building is a low rise structure in an Exposure B region where the ultimate design wind speed is 180 mph. The building is a Category II structure. The mean height of the building is 30 feet. The roof is a gable roof with a roof slope of 3:12. The terrain around the building does not abruptly change so as to create any wind speedup effects due to channeling, or shielding. The building is not located on a hill, ridge, or escarpment that would cause the wind to speedup. The roof tiles will be flat/low profile concrete roof tile with a total tile length of 16-1/2" and exposed width of 11". The roof tiles weigh 9 pounds each. The roof covering is installed direct to deck on solid sheathing.

Calculate the Required Aerodynamic Uplift Moment and use the Allowable Aerodynamic Uplift Resistance from Table 9. Risk Category from Table 1.5-1 (ASCE 7-10): Velocity pressure: $q_h = 0.00256 * K_z * K_{zt} * K_d * V^2$

q_h = velocity pressure at height z (psf)

K_z = velocity pressure exposure coefficient at height z (ASCE-7-10 Table 30.3-1) $K_z = 0.7$ for example from Table 30.3-1)

K_{zt} = topographic factor: $K_{zt} = 1.0$ (ASCE 10-11, Section 26, 8.2)

K_d = wind directionality factor: ASCE 7-10, Table 26.6-1 ($K_d = 0.85$)

V = basic wind speed (mph) Fig. 26.5-1A (180 mph)

$q_h = .00256 * K_z * K_{zt} * K_d * V^2 = .00256 (0.7) (0.85) (1.0) (180\text{mph}^2)$

$q_h = 49.35$ psf

Required Aerodynamic Uplift Moment

$M_a = q_h C_L b L L_a (1.0-GC)$

b = Exposed width, feet of the roof tile = 11" = 0.917'

C_L = Lift Coefficient = 0.2 (IBC - Section 1609.5.3)

$GC_p = -2.6$, Roof pressure coefficient for each applicable roof zone determined from Figure 30.4-2B in Chapter 30 of ASCE 7-10. Roof Coefficient shall not be adjusted for internal pressure.

L = Length, feet of the roof tile = 16.5" = 1.375'

L_a = moment arm for the roof tile = 0.76L (IBC Section 1609.5.3) = 0.76 (1.375') = 1.045'

M_a = Aerodynamic uplift moment, feet-pounds acting to raise the tail of the tile

q_h = Wind velocity pressure, psf determined from Chapter 30, ASCE 7-10.

$$M_a = 0.6_{qh} C_L b L L_a (1-GC_p) = (0.6)49.35 (0.2) (.917) (1.375) (1.045) (1-(-2.6))$$

$$M_a = 28.1 \text{ ft-lbf}$$

Required Aerodynamic Uplift Resistance

For a direct deck installation select a fastening system from Table 11, Allowable Uplift Moments - A mechanical fastening system that is equal to or greater than 28.1 ft-lbf will be required.

From Table 11 a 2-10d ring shank nail or 1 #8 screw at 39.1 ft-lbf would be selected.

Example 2

The building is the same as in example 1, except the flat/low concrete roof tile in this example is now within the combined maximum tile length and maximum exposed width listed in Table 10A (1.407 ft³) for the allowable tile length and tile's exposed width. This roof tile may be designed using the appropriate Table 9A and Table 9B. Based on the exposure and the roof pitch, the appropriate table is Table 9A, (Required Aerodynamic Uplift Moment for Tile). Exposure B Table 9A indicates that the required aerodynamic uplift moment for this roof covering, **M_a is 30.0 ft-lbf.**

Note: The difference between the M_a's in Example 1 and Example 2 is in the tile factor in Example 2. Table 9A and Table 9B are based on a tile factor of 1.407 ft³ while the actual tile factor for this roof tile is 1.318 ft³. (Tile Factor = b•L•L_a = (0.917) (1.375) (1.045) = 1.318 ft³. See Table 10A for maximum dimensions to Satisfy Tile Factor of 1.407ft³.

Required Aerodynamic Uplift Resistance

For a direct deck installation select a fastening system from Table 11, Allowable Uplift Moments - a mechanical fastening system that is equal to or greater than 30 ft-lbf will be required. From Table 11 a 2-10d ring shank nail or 1 #8 screw at 39.1 ft-lbf would be selected.

Example 3

The same building as found in example 1, but design the roof tile installation for a lightweight roof tile. The roof tile installation is identical to the previous examples except that the lightweight roof tiles weigh 5 pounds each. The flat/low lightweight concrete roof tile is within the combined maximum tile length and maximum exposed width listed in Table 10A, Maximum Dimensions to Satisfy Tile Factor. This roof tile may be designed using the appropriate Table 9A or Table 9B.

Required Aerodynamic Uplift Moment

Based on the exposure and the roof pitch the appropriate table is Table 9A, Exposure B - Required Aerodynamic Uplift Moment. Aerodynamic uplift moment for this roof covering

indicates that the required aerodynamic uplift moment for this roof covering, **M_a, is 30.0 ft-lbf.**

Mechanical Attachment Resistance

For a direct deck installation select a fastening system from Table 11, Allowable Uplift Moment-Mechanical Fastening Systems select an attachment resistance that is equal to or greater than 30.0 ft-lbf.

From Table 11 a 2-10d ring shank nail or 1 #8 screw at 39.1 ft-lbf would be selected.

Attachment Resistance

Determine the attachment resistance with the generic restoring gravity moment used in Table 11. Footnote 11 for Table 11 states that the table is based on a generic restoring gravity moment of 6.5 ft-lbf for a direct deck installation and 5.5 ft-lbf for a batten installation. Based on a direct deck installation the attachment resistance for 1-#8 screw is 32.6 ft-lbf.

$$M_f = 39.1 \text{ ft-lbf} - 6.5 \text{ ft-lbf} = 32.6 \text{ ft-lbf}$$

Restoring Gravity Moment:

From Table 10B, the restoring gravity moment for a roof tile weighing 5 lbs. is 3.17 ft-lbf.

$$M_s = 3.17 \text{ ft-lbf (Table 6B)}$$

Allowable Aerodynamic Uplift Resistance

The allowable aerodynamic uplift resistance for the flat/low lightweight concrete roof tile is the sum of the attachment resistance plus the restoring gravity moment of the flat/low lightweight concrete roof tile. See Table 10B for Restoring Gravity Moment for various tile weights.

$$\text{Allowable Aerodynamic Uplift Resistance, } M_{all} = M_f + M_g = 32.6 \text{ ft-lbf} + 3.17 \text{ ft-lbf} = 35.77 \text{ ft-lbf}$$

$$M_{all} = 35.8 \text{ ft-lbf} \quad M_a = 30.0 \text{ ft-lbf}$$

The use of 1-#8 screw to install each lightweight roof tile complies with the code for uplift resistance.

Note: For consideration of attachment of underlayments in high winds areas under the 2012 IBC and 2012 IRC, see Section 1507.3.3.3 of the 2012 IBC and Section R905.3.3.3 of the 2012 IRC. Attachment of underlayments must comply with the above mentioned sections.

$$M_a = 0.6_{qh} C_L^{bLL} (1-GC_p) = (0.6)49.35 (0.2) (.917) (1.375) (1.045) (1-(-2.6))$$

$$M_a = 28.1 \text{ ft-lbf}$$

Required Aerodynamic Uplift Resistance

For a direct deck installation select a fastening system from Table 11, Allowable Aerodynamic Uplift Moment-Mechanical Fastening System select an attachment resistance that is equal to or greater than 30.0 ft-lbf.

From Table 11: 2-10d ring shank nail or 1 #8 screw at 39.1 ft-lbf would be selected

EXAMPLE 4

The building is the same as in example 1, except the flat/low concrete roof tile in this example is now within the combined maximum tile length and maximum exposed width listed in Table 10A (1.407 ft²) for the allowable tile length and tile's exposed width. This roof tile may be designed using the appropriate Table 9A and Table 9B. Based on the exposure and the roof pitch, the appropriate table is Table 5A, (Required Aerodynamic Uplift Moment for Tile). Exposure B Table 9A indicated that the required aerodynamic uplift moments for this roof covering. **M_a is 30.0 ft-lbf.**

Note: the difference between the M_a's in Example 1 and Example 4 is in the tile factor in Example 4. Table 9A and Table 9B are based on a tile factor of 1.407 ft³ while the actual tile factor for this roof tile is 1.318 ft³. (Tile Factor = b L L_a = (0.917) (1.375) (1.045) = 1.318 ft³. See Table 10A for maximum dimensions to Satisfy Tile Factor of 1.407ft³.

Required Aerodynamic Uplift Resistance

For a direct deck installation select a fastening system from Table 11. Allowable Aerodynamic Uplift Moments - A mechanical fastening system that is equal to or greater than 30 ft-lbf will be required. From Table 11: 2-10d ring shank nail or 1 #8 screw at 39.1 ft-lbf would be selected.

EXAMPLE 5

The same building as found in example 1, but design the Roof Tile Installation for a Lightweight Roof Tile. The roof tile installation is identical to the previous examples except that the lightweight roof tiles weight 5 pounds each. The flat/low lightweight concrete roof tile is within the combined maximum tile length and maximum exposed width listed in Table 6A, Maximum Dimensions to Satisfy Tile Factor. This roof tile may be designed using the appropriate Table 9A or Table 9B.

Required Aerodynamic Uplift Moment

Based on exposure and the roof pitch the appropriate table is Table 9A, Exposure B-Required Aerodynamic Uplift

Moment. Aerodynamic uplift moment for this roof covering indicates that the required aerodynamic uplift moment for this roof covering **M_a is 30.0 ft-lbf.**

Mechanical Attachment Resistance

For a direct deck installation select a fastening system from Table 11, Allowable Aerodynamic Uplift Moment-Mechanical Fastening Systems select an attachment resistance that is equal to or greater than 30.0 ft-lbf.

From Table 11: a 2-10d ring shank nail or 1 #8 screw at 39.14 ft-lbf would be selected.

Attachment Resistance

Determine the attachment resistance with the generic restoring gravity moment used in Table 11. Footnote 11 for Table 11 states that the table is based on a generic restoring gravity moment of 6.5 ft-lbf for a direct deck installation and 5.5 ft-lbf for a batten installation. Based on a direct deck installation the attachment resistance for 1-#8 screw is 32.6 ft-lbf.

$$M_f = 39.1 \text{ ft-lbf} - 6.5 \text{ ft-lbf} = 32.6 \text{ ft-lbf}$$

Restoring Gravity Moment:

From Table 10B, the restoring gravity moment for a roof tile weighting 5lbs. is 3.17 ft-lbf.

$$M_g = 3.17 \text{ ft-lbf (Table 10B)}$$

Allowable Aerodynamic Uplift Resistance

The allowable aerodynamic uplift resistance for the flat-low lightweight concrete roof tile is the sum of the attachment resistance plus the restoring gravity moment of the flat/low lightweight concrete roof tile. See Table 10B for Restoring Gravity Moment for various tile weights.

$$\text{Allowable Aerodynamic Uplift Resistance, } M_{all} = M_f + M_g = 32.6\text{ft-lbf} + 3.17 \text{ ft-lbf} = 35.77 \text{ ft-lbf}$$

$$M_{all} = 35.8 \text{ ft-lbf } M_a = 30.0 \text{ ft-lbf}$$

The use of 1- #8 screw to install each lightweight roof tile complies with the code for uplift resistance.

Note: For consideration of attachment of underlayments in high winds areas under the 2012 IBC and 2012 IRC, see Section 1507.3.3.3 of the 2012 IBC and Section R905.3.3.3 of the 2012 IRC. Attachment of underlayments must comply with the above mentioned sections.

TABLE 9A (ASCE 7-10)
Required Aerodynamic Uplift Moment For Tile, Zone 3
Ma (ft-lbf) For Roof Pitches 6:12 and Less
Gable Roof 2 ½:12 < θ < 6:12 (12° < θ < 27°)
Hip Roof 5 ½:12 < θ < 6:12 (25° < θ < 27°)

Exposure B	Ultimate Design Wind Speed in MPH									
	MRH	110	120	130	140	150	160	170	180	190
0-15	11.2	13.3	15.6	18.1	20.8	23.7	26.8	30.0	33.4	
20	11.2	13.3	15.6	18.1	20.8	23.7	26.8	30.0	33.4	
25	11.2	13.3	15.6	18.1	20.8	23.7	26.8	30.0	33.4	
30	11.2	13.3	15.6	18.1	20.8	23.7	26.8	30.0	33.4	
35	11.7	13.9	16.3	18.9	21.7	24.7	27.9	31.3	34.9	
40	12.2	14.5	17.0	19.7	22.6	25.7	29.1	32.6	36.3	
45	12.5	14.9	17.4	20.2	23.2	26.4	29.8	33.4	37.2	
50	12.9	15.4	18.1	21.0	24.1	27.4	31.0	34.7	38.7	
55	13.3	15.8	18.6	21.5	24.7	28.1	31.7	35.6	39.6	
60	13.6	16.2	19.0	22.0	25.3	28.8	32.5	36.4	40.6	
Exposure C	Ultimate Design Wind Speed in MPH									
MRH	110	120	130	140	150	160	170	180	190	
0-15	13.6	16.2	19.0	22.0	25.3	28.8	32.5	36.4	40.6	
20	14.4	17.1	20.1	23.3	26.8	30.5	34.4	38.6	43.0	
25	15.0	17.9	21.0	24.4	28.0	31.8	35.9	40.3	44.9	
30	15.7	18.7	21.9	25.4	29.2	33.2	37.5	42.0	46.8	
35	16.1	19.2	22.6	26.2	30.1	34.2	38.6	43.3	48.2	
40	16.6	19.8	23.2	27.0	30.9	35.2	39.8	44.6	49.7	
45	17.0	20.2	23.7	27.5	31.5	35.9	40.5	45.4	50.6	
50	17.5	20.8	24.4	28.3	32.4	36.9	41.7	46.7	52.0	
55	17.7	21.1	24.8	28.8	33.0	37.6	42.4	47.6	53.0	
60	18.1	21.5	25.3	29.3	33.6	38.3	43.2	48.4	54.0	
Exposure D	Ultimate Design Wind Speed in MPH									
MRH	110	120	130	140	150	160	170	180	190	
0-15	16.5	19.6	23.0	26.7	30.7	34.9	39.4	44.1	49.2	
20	17.3	20.6	24.1	28.0	32.1	36.6	41.3	46.2	51.6	
25	19.9	21.3	25.0	29.0	33.3	37.9	42.8	48.0	53.5	
30	18.6	22.1	25.9	30.1	34.5	39.3	44.3	49.7	55.4	
35	19.1	22.7	26.6	30.8	35.4	40.3	45.5	51.0	56.8	
40	19.5	23.2	27.3	31.6	36.3	41.3	46.6	52.2	58.3	
45	20.0	23.8	27.9	32.4	37.2	42.3	47.8	53.5	59.7	
50	20.3	24.2	28.4	32.9	37.8	43.0	48.5	54.4	60.6	
55	20.7	24.6	28.8	33.4	38.4	43.7	49.3	55.2	61.6	
60	20.9	24.9	29.3	34.0	39.0	44.4	50.1	56.1	62.5	

Wind Speeds are per ASCE 7-10 for Ultimate Design Wind Speed at 33 ft above ground. MRH=Mean Roof Height in Feet For Roof Pitches 6:12 and Less Equates to Roof Slopes 12 deg < θ < 27 deg for Zone 3.

TABLE 9B (ASCE 7-10)
Required Aerodynamic Uplift Moment For Tile, Zone 3
Ma (ft-lbf) For Roof Pitches Greater Than 6:12
Hip Roof $2\frac{1}{2}:12 < \theta < 5\frac{1}{2}:12$ ($12^\circ < \theta < 25^\circ$)

Exposure B		Ultimate Design Wind Speed in MPH							
MRH	110	120	130	140	150	160	170	180	190
0-15	8.4	10.0	11.7	13.6	15.6	17.8	20.1	22.5	25.1
20	8.4	10.0	11.7	13.6	15.6	17.8	20.1	22.5	25.1
25	8.4	10.0	11.7	13.6	15.6	17.8	20.1	22.5	25.1
30	8.4	10.0	11.7	13.6	15.6	17.8	20.1	22.5	25.1
35	8.8	10.4	12.2	14.2	16.3	18.5	20.9	23.5	26.1
40	9.1	10.9	12.7	14.8	17.0	19.3	21.8	24.4	27.2
45	9.4	11.1	13.1	15.2	17.4	19.8	22.4	25.1	27.9
50	9.7	11.6	13.6	15.7	18.1	20.6	23.2	26.0	29.0
55	10.0	11.9	13.9	16.1	18.5	21.2	23.8	26.7	29.7
60	10.2	12.1	14.2	16.5	19.0	21.6	24.4	27.3	30.4
Exposure C		Ultimate Design Wind Speed in MPH							
MRH	110	120	130	140	150	160	170	180	190
0-15	10.2	12.1	14.2	16.5	19.0	21.6	24.4	27.3	30.4
20	10.8	12.9	15.1	17.5	20.1	22.9	25.8	28.9	32.2
25	11.3	13.4	15.8	18.3	21.0	23.9	26.9	30.2	33.7
30	11.8	14.0	16.4	19.1	21.9	24.9	28.1	31.5	35.1
35	12.1	14.4	16.9	19.5	22.5	25.6	29.0	32.5	36.2
40	12.5	14.9	17.4	20.2	23.2	26.4	29.8	33.4	37.2
45	12.7	15.1	17.8	20.6	23.7	26.9	30.4	34.1	38.0
50	13.1	15.6	18.3	21.2	24.3	27.7	31.2	35.0	39.0
55	13.3	15.9	18.6	21.6	24.8	28.2	31.8	35.7	39.7
60	13.6	16.1	18.9	22.0	25.2	28.7	32.4	36.2	40.5
Exposure D		Ultimate Design Wind Speed in MPH							
MRH	110	120	130	140	150	160	170	180	190
0-15	12.4	14.7	17.3	20.0	23.0	26.2	29.5	33.1	36.9
20	13.0	15.4	18.1	21.0	24.1	27.4	31.0	34.7	38.7
25	13.4	16.0	18.8	21.8	25.0	28.4	32.1	36.0	40.1
30	13.9	16.6	19.4	22.6	25.9	29.5	33.3	37.3	41.5
35	14.3	17.0	19.9	23.1	26.6	30.2	34.1	38.2	42.6
40	14.6	17.4	20.5	23.7	27.2	31.0	35.0	39.2	43.7
45	15.0	17.9	21.0	24.3	27.9	31.7	35.8	40.2	44.8
50	15.2	18.1	21.3	24.7	28.3	32.3	36.4	40.8	45.5
55	15.5	18.4	21.6	25.1	28.8	32.8	37.0	41.5	46.2
60	15.7	18.7	22.0	25.5	29.2	33.3	37.6	42.1	46.9

Wind Speeds are per ASCE 7-10 for Ultimate Design Wind Speed at 33 ft above ground. MRH=Mean Roof Height in Feet For Roof Pitches Less Than 6:12 Equates to Roof Slopes 12 deg θ < 25 deg for Zone 3.

TABLE 9C (ASCE 7-10)
Required Aerodynamic Uplift Moment For Tile, Zone 3
Ma (ft-lbf) For Roof Pitches Greater Than 6:12
Gable Roof 6:12 < θ < 12:12 (27° < θ < 45°)

Exposure B	Ultimate Design Wind Speed in MPH								
MRH	110	120	130	140	150	160	170	180	190
0-15	6.8	8.1	9.6	11.1	12.7	14.5	16.4	18.3	20.4
20	6.8	8.1	9.6	11.1	12.7	14.5	16.4	18.3	20.4
25	6.8	8.1	9.6	11.1	12.7	14.5	16.4	18.3	20.4
30	6.8	8.1	9.6	11.1	12.7	14.5	16.4	18.3	20.4
35	7.1	8.5	10.0	11.6	13.3	15.1	17.1	19.1	21.3
40	7.4	8.8	10.4	12.0	13.8	15.7	17.8	19.9	22.2
45	7.6	9.1	10.7	12.4	14.2	16.1	18.2	20.4	22.8
50	7.9	9.4	11.1	12.8	14.7	16.8	18.9	21.2	23.6
55	8.2	9.7	11.3	13.1	15.1	17.2	19.4	21.7	24.2
60	8.3	9.9	11.6	13.5	15.5	17.6	19.9	22.3	24.8
Exposure C	Ultimate Design Wind Speed in MPH								
MRH	110	120	130	140	150	160	170	180	190
0-15	8.3	9.9	11.6	13.5	15.5	17.6	19.9	22.3	24.8
20	8.8	10.5	12.3	14.3	16.4	18.6	21.0	23.6	26.3
25	9.2	10.9	12.8	14.9	17.1	19.5	22.0	24.6	27.4
30	9.6	11.4	13.4	15.5	17.8	20.3	22.9	25.7	28.6
35	9.9	11.8	13.8	16.0	18.4	20.9	23.6	26.4	29.5
40	10.2	12.1	14.2	16.5	18.9	21.5	24.3	27.2	30.3
45	10.3	12.3	14.5	16.8	19.3	21.9	24.8	27.8	30.9
50	10.7	12.7	14.9	17.3	19.8	22.6	25.5	28.5	31.8
55	10.8	12.9	15.2	17.6	20.2	23.0	25.9	29.1	32.4
60	11.1	13.2	15.4	17.9	20.6	23.4	26.4	29.6	33.0
Exposure D	Ultimate Design Wind Speed in MPH								
MRH	110	120	130	140	150	160	170	180	190
0-15	10.1	12.0	14.1	16.3	18.7	21.3	24.1	27.0	30.1
20	10.6	12.6	14.8	17.1	19.6	22.3	25.2	28.3	31.5
25	10.9	13.0	15.3	17.7	20.4	23.2	26.2	29.3	32.7
30	11.3	13.5	15.8	18.4	21.1	24.0	27.1	30.4	33.8
35	11.7	13.9	16.3	18.9	21.6	24.6	27.8	31.2	34.7
40	11.9	14.2	16.7	19.3	22.2	25.2	28.5	31.9	35.6
45	12.2	14.5	17.1	19.8	22.7	25.9	29.2	32.7	36.5
50	12.4	14.8	17.3	20.1	23.1	26.3	29.7	33.3	37.1
55	12.6	15.0	17.6	20.4	23.5	26.7	30.1	33.8	37.6
60	12.8	15.2	17.9	20.8	23.8	27.1	30.6	34.3	38.2

Wind Speeds are per ASCE 7-10 for Ultimate Design Wind Speed at 33 ft above ground. MRH=Mean Roof Height in Feet For Roof Pitches Greater Than 6:12 Equates to Roof Slopes 27 deg < θ < 45 deg for Zone 3.

TABLE 9D (ASCE 7-10)
Required Aerodynamic Uplift Moment For Tile, Zone 3, Ma (ft-lbf)
For Monoslope Pitches $2\ 1/2:12 < \theta < 6\ 3/4:12$ ($12^\circ < \theta < 30^\circ$)

Ultimate Design Wind Speed in MPH									
Exposure B	110	120	130	140	150	160	170	180	190
MRH	110	120	130	140	150	160	170	180	190
0-15	12.1	14.4	17.0	19.7	22.6	25.7	29.0	32.5	36.2
20	12.1	14.4	17.0	19.7	22.6	25.7	29.0	32.5	36.2
25	12.1	14.4	17.0	19.7	22.6	25.7	29.0	32.5	36.2
30	12.1	14.4	17.0	19.7	22.6	25.7	29.0	32.5	36.2
35	12.7	15.1	17.7	20.5	23.5	26.8	30.2	33.9	37.8
40	13.2	15.7	18.4	21.3	24.5	27.9	31.5	35.3	39.3
45	13.5	16.1	18.9	21.9	25.1	28.6	32.3	36.2	40.3
50	14.0	16.7	19.6	22.7	26.1	29.7	33.5	37.6	41.9
55	14.4	17.1	20.1	23.3	26.8	30.4	34.4	38.5	42.9
60	14.7	17.5	20.6	23.9	27.4	31.2	35.2	39.5	44.0
Exposure C	110	120	130	140	150	160	170	180	190
MRH	110	120	130	140	150	160	170	180	190
0-15	14.7	17.5	20.6	23.9	27.4	31.2	35.2	39.5	44.0
20	15.6	18.6	21.8	25.3	29.0	33.0	37.3	41.8	46.6
25	16.3	19.4	22.8	26.4	30.3	34.5	38.9	43.6	48.6
30	17.0	20.2	23.7	27.5	31.6	35.9	40.6	45.5	50.7
35	17.5	20.8	24.5	28.4	32.6	37.0	41.8	46.9	52.2
40	18.0	21.5	25.2	29.2	33.5	38.1	43.1	48.3	53.8
45	18.4	21.9	25.7	29.8	34.2	38.9	43.9	49.2	54.8
50	18.9	22.5	26.4	30.6	35.1	40.0	45.1	50.6	56.4
55	19.2	22.9	26.9	31.2	35.8	40.7	46.0	51.5	57.4
60	19.6	23.3	27.4	31.7	36.4	41.4	46.8	52.5	58.4
Exposure D	110	120	130	140	150	160	170	180	190
MRH	110	120	130	140	150	160	170	180	190
0-15	17.9	21.3	24.9	28.9	33.2	37.8	42.7	47.8	53.3
20	18.7	22.3	26.2	30.3	34.8	39.6	44.7	50.1	55.9
25	19.4	23.1	27.1	31.5	36.1	41.1	46.4	52.0	57.9
30	20.1	23.9	28.1	32.6	37.4	42.5	48.0	53.9	60.0
35	20.6	24.6	28.8	33.4	38.4	43.7	49.3	55.2	61.6
40	21.2	25.2	29.5	34.3	39.3	44.8	50.5	56.6	63.1
45	21.7	25.8	30.3	35.1	40.3	45.9	51.8	58.0	64.7
50	22.0	26.2	30.8	35.7	40.9	46.6	52.6	59.0	65.7
55	22.4	26.6	31.2	36.2	41.6	47.3	53.4	59.9	66.7
60	22.7	27.0	31.7	36.8	42.2	48.1	54.2	60.8	67.8

Wind Speeds are per ASCE 7-10 for Ultimate Design Wind Speed at 33 ft above ground. MRH=Mean Roof Height in Feet For Roof Pitches $6\ 3/4:12$ and Less Equates to Roof Slopes $12\ \text{deg} < \theta < 30\ \text{deg}$ for Zone 3.

**TABLE 10A (ASCE 7-10)
MAXIMUM DIMENSIONS TO SATISFY TILE FACTOR OF 1.407 ft³**

Maximum Combination of Tile Length and Tile's Exposed Width										
Maximum Tile Length (inches)	20	18-1/2	18	17-1/2	16-1/2	16	15-1/2	15	14-1/2	14
Maximum Exposed Width (inches)	8	9-1/4	9-3/4	10-1/4	11-3/4	12-1/2	13-1/4	13-3/4	14	15

**TABLE 10B (ASCE 7-10)
RESTORING GRAVITY MOMENT**

Maximum Combination of Tile Length and Tile's Exposed Width						
Tile Weight (lbs)	5	6	7	8	9	10
Mg (ft-lbf)	3.17	3.80	4.43	5.06	5.7	6.33

Notes for Tables 9A through 10B:

1. Roof tiles shall comply with the following dimensions:
 - (1) The total length of the roof tile shall be between 1.0 foot and 1.75 feet.
 - (2) The exposed width of the roof tile shall be between 0.67 feet and 1.25 feet.
 - (3) The maximum thickness of the tail of the roof tile shall not exceed 1.3 inches.
2. The required aerodynamic uplift moments in these tables are based on a roof tile that has a Tile Factor of 1.407 ft³. The required aerodynamic uplift moment for roof tiles with a Tile Factor other than 1.407 ft³ may be determined by using the following procedure. These tables are conservative for roof tiles with a Tile Factor less than 1.407 ft³.
 - (1) Calculate the Tile Factor for the desired roof tile.

$$\text{Tile Factor} = b(L)(L_a)$$

$$b = \text{exposed width of the roof tile (ft)}$$

$$L = \text{total length of roof tile (ft)}$$

$$L_a = \text{moment between point of rotation and the theoretical location of the resultant of the wind uplift force.}$$
 For the standard roof tiles the moment arm = 0.76 L (See IBC - Section 1609.5.3)
 - (2) Based on exposure, roof style, roof pitch, ultimate design wind speed, and mean roof height, select the appropriate required aerodynamic uplift moment from the tables for the desired roof tile.
 - (3) Multiply the selected required aerodynamic uplift moment by the ratio of the tile factor for the desired roof tile and 1.407 ft³.
 - (4) Select an attachment system that is equal to or greater than the calculated required aerodynamic uplift moment in step 3.
3. Table 10A provides a combination of exposed widths and total lengths that generate a Tile Factor of 1.407 ft³. The table "Maximum Combination of Tile Length and Tile's Exposed Width" provides a listing of tiles that fit this Tile Factor.

TABLE 11 (ASCE 7-10)
Mechanical Roof Tile Resistance Values (ft-lbf) For Tile

Deck Thickness	Method	Fastner Type	Low	Medium	High
15/32"	Direct Deck	1-10d smooth or screw shank nail, with clip	25.2	25.2	35.5
		2-10d, smooth or screw shank nail, with clip	38.1	38.1	44.3
		2- 10d ring shank nail	39.1	36.1	28.6
		2- 10d ring shank nail, with 4" head lap	50.3	43.0	33.1
	Batten	1- #8 Screw	39.1	33.2	28.7
		2- #8 screw	50.2	55.5	51.3
		1-10d smooth or screw shank nail, with clip	27.5	27.5	29.4
		2-10d smooth or screw shank nail, with clip	37.6	37.6	47.2
19/32"	Direct Deck	2- 10d ring shank nail	46.4	45.5	41.2

SS = Smooth Shank Nail or Screw Shank RS = Ring Shank

C = Clip HL = Head Lap

For mean roof heights over 60 ft, engineering calculations must be submitted for permitting.

Notes for Table 11:

- For attachment systems not listed in the table for 19/32" sheathing use the allowable aerodynamic uplift resistance from the table for 15/32" sheathing.
- Fasteners shall have a minimum edge distance of 1-1/2 inches from the head of the tile and located in the pan of the tile to obtain the values in Table 7. Consult the tile manufacturer for additional limitations or restrictions.
- Ring shank nails shall be 10d ring shank corrosion resistant steel nails with the following minimum dimensions: (3 inches long, 0.283 inch flat head diameter, 0.120 inch undeformed shank diameter or 0.131 inch screw diameter).
- Smooth or screw shank nails shall be 10d corrosion resistant steel (with the following minimum dimension. 3 inch long, 0.283 inch flat head diameter, 0.120 inch undeformed shank diameter or 0.131 inch screw diameter).
- Screws are #8 course threaded, 2.5 inches long corrosion-resistant steel wood screws conforming to ANSI/ASME B 18.6.1.
- The fastener hole nearest the overlock shall be used when a single nail or screw is required. The fastener hole nearest the underlock and the fastener hole nearest the overlock shall be used when two nails or screws are required.
- When using eave and field clips, attachment of the tiles is accomplished by a combination of nails and clips. Tiles are nailed to the sheathing or through the battens to the sheathing with one or two 10d corrosion resistant nails (Note 2 and 3 above) as required by Tables 5 and 6. Additionally, each tile is secured with a 0.060 inch thick and 0.5 inch wide clip which is secured to the plywood sheathing or eave fascia, as appropriate, with a single nail per clip. The nail shall be placed in the hole closest to the tile for clips having more than one nail hole. The following clip/nail combinations are permitted:
 - Aluminum alloy clip with 1.25 inch HD galvanized roofing nail (0.128 inch shank diameter).
 - Galvanized steel deck clip with 1.25 inch HD galvanized roofing nail (0.128 inch shank diameter).
 - Stainless steel clip with 1.25 inch HD galvanized roofing nail (0.128 inch shank diameter).
- Field clips and eave clips are to be located along the tile where the clip's preformed height and the tile's height above the underlayment are identical.
- Counter batten values not included.
- For attachment systems not listed in table for 15/32" sheathing, use allowable aerodynamic uplift moment from table for 15/32" sheathing.
- The allowable aerodynamic uplift moments include a generic restoring gravity moment of 6.5 ft-lbf for a direct deck installation and a generic restoring gravity moment of 5.5 ft-lbf for a batten installation.

Additional Notes outside the scope of Uniform ES ER-2015 or this manual
Allowable Aerodynamic Uplift Moments Adhesive Fastening Systems

Refer to the adhesive manufacturer for the allowable aerodynamic uplift moment for the installation method used to comply with the applicable code requirements. Installation of roof tiles using the adhesive system should be done by technicians trained and having a current certification by the adhesive manufacturer to comply with the applicable code requirements.

Allowable Aerodynamic Uplift Moments
Mortar Fastening Systems

Refer to the pre-bagged mortar mix manufacturer for the allowable aerodynamic uplift moment for the installation method used to comply with the applicable code requirements. Mixing of mortar at the jobsite is not a recommended practice. Installation of roof tiles using the mortar system should be done by technicians trained and having a current certification by the mortar mix manufacturer to comply with the applicable code requirements.

GLOSSARY OF TERMS

Abutment: The intersection between the roof and the chimney, wall or other vertical face.

Adhesives: A bonding agent to join two surfaces for the purpose of permanent attachment as approved by the local building official.

Anti-Ponding: A device such as beveled cant strip or shop-formed sheet metal is recommended at all raised fascia conditions to support the underlayment.

Batten: A nonstructural horizontal fastening strip to which the roof tiles are attached.

Batten Lugs: Protrusions (anchor lugs) on the underside of the tile designed to engage over the upper edge of tiling battens.

Bedding: Refers to the installation of roof tiles to a mortar or adhesive foam patty and is structural in nature for the basic securement.

Bird Stop: A product used at the eave of a profile tile roof to stop birds from entering below the tile.

Booster Tile: Normally 3"-4" long tile strip used to lift up the cover tile. Sometimes it is used in boosting up field tile to create an authentic looking roof.

Cant Angle: The angle formed between the upper surface of the installed roof tile and the roof deck.

Clay Rooftile: An interlocking or non-interlocking clay roof covering, used to cover the roof surface.

Concrete Rooftile: An interlocking, or non-interlocking concrete roof covering, used to cover the roof surface.

Counter Battens: Vertical furring strips running beneath and perpendicular to horizontal tile batten, to allow drainage and air flow beneath the roof tile. Also known as strapping.

Counter Flashing: A flashing material that provides the enclosure at the transition line between the roof to wall flashing at intersecting vertical surfaces.

Counter Batten System: A method of elevating horizontal battens above the roof deck to allow drainage and air flow

beneath the horizontal battens and roof tile

Cricket: See Saddle.

Dead Loads: The weight of all materials of construction incorporated into the roof assembly including but not limited to, fixed service equipment, roof tiles, battens, underlayment, flashing, roof deck, etc.

Direct Deck: Those tiles fastened directly to the roof deck without the use of battens.

Eave: Outer edge of the roof downslope.

Eave Closure: A material available for S-tile or Pan and Cover tile. Eave closures are used to close the convex opening created by the shape of the tile at the eave. This accessory also provides the proper rise for the first course of tile. See Bird Stop.

Eave Riser: Method/material used for elevating the nose of the first course of tile to the plane of the field tile.

Fascia: A decorative board concealing the lower ends of the rafters or the outer edge of the gable.

Flashing: Impervious material used to cover, waterproof, and direct water away from roof penetrations and from intersections between the roof tile and other materials.

Fully Engaged: The horizontal batten material thickness shall be equal to or greater than the design depth of the anchor lug of the tile.

Gable End: The generally triangular area at the end of a sloped roof extending from the eaves to the ridge.

Head Lap: The measurement of the overlap between a course of roofing components and the course above.

Headwall Flashing: The flashing that is installed at the horizontal, intersecting wall or other vertical surface.

Hem: An edge of metal bent back on its self to give strength to the edge of the metal.

High Profile Tile: Those tiles having a rise to width ratio greater than 1:5. (Typically referred to as "S" or barrel, 2-piece, Pan & Cover tile). Measured in the installed condition.

Hip: The exterior sloping ridge formed by the intersection of two inclined roof surfaces.

Hip/Ridge Tile: Accessory trim tile used to cover a hip or a ridge.

Hip Starter: The closed hip piece which is used at the outside corner, intersecting of two eaves to start the hip tile.

Interlocking Tile: Those tiles with a system of rib(s) or groove(s) enabling the joining of adjacent tiles in the same horizontal or vertical row, with the overlapping lock covering the underlapping lock.

Length: The maximum overall dimension of the tiles as measured parallel to the water course.

Live Loads: A load produced by the use and occupancy of the building or other structure that does not include construction or environmental loads, such as wind load, snow load, rain load, earthquake load, flood load, or dead load.

Low Profile Tile: Low profile tiles are defined as those flat tiles having a top surface rise equal to or less than $\frac{1}{2}$ ".

Medium Profile Tile: Tiles having a rise greater than $\frac{1}{2}$ " and a rise to width ratio of less than or equal to 1:5.

Metal Drip Edge: Perimeter metal flashing installed to protect raw edges of roof deck.

Mortar: A mixture of cementitious material, aggregate, and water used for bedding, jointing, and bonding of masonry or roof tile and accessories.

Nail Hole: A small opening passing partially or totally through the tiles to allow the penetration of a nail, screw or other approved fastener for the purpose of fastening the tile to a support.

Nailer Board/Stringer: A piece of wood or other material of proper height, attached to a roof at the ridge and/or hips to allow for proper support and means of attachment for the hip and ridge tile. Can also be used in pan and cover applications under the cover tile for proper support. (Commonly known as a vertical stringer)

Non-Interlocking Tile: Those tile that do not have vertical rib(s) or grooves creating an interlocking tile.

Nose Clips: A fastening device designed to hold the nose (or butt) end of the tile against uplift or sliding down the slope. Also known as wind clips or tile locks.

Nose Lugs: Protrusion(s) on the underside of the tile that are designed to restrict the flow of weather between two consecutive courses of tile.

Pan and Cover Tile: Semi-circular shape tile. Also known as two piece mission or barrel mission tile. There are tapered and straight two piece mission styles available.

Pan Flashing: Metal flashing running under the tile at the side walls.

Point-up: The application of mortar to fill voids to various ends, sides and angles of a tile roof, which are non structural in nature.

Profile: The contour of the top surface of the tiles when viewed from the nose end.

Rake Trim: A roof tiling accessory used to cover the intersection between the gable end and a roof.

Ridge Trim: The piece of ridge available to close off the gable end and peak of a roof. Some ridge tile have an interlocking feature and require either a "starter" or "finisher".

Ridge Tile: See hip/ridge tile.

Roof Live Load: A load on the roof produced (1) during the maintenance by workers, equipment, and materials and (2) during the life of the structure by moveable objects, such as planters or other similar small decorative appurtenances that are not occupancy related.

Saddle Flashing: The flashing at the upper intersection between a chimney or skylight and the roof. (Commonly referred to as a Cricket or Backpan)

Side Clips: A fastening device for tile with a side interlock designed to prevent rotation of the tile when subjected to uplifting forces. Also known as hurricane clip.

Side Lap: The measurement of the overlap between a roofing component and a component to one side of it.

Side Wall: The vertical intersection that runs parallel to the roof slope.

Spaced Sheathing: Sheathing boards or battens, which are mechanically attached to the rafters or framing members, with gaps or spaces between them and is used in lieu of a solid sheathing.

Standard Weight Rooftile: Roof tile of mass/unit area of 9 lbs/ft² or greater installed weight excluding all other roofing components.

Starter Tile: First course of cover tile for two piece misson. Normally 3"-4" shorter than the field tile.

Step Flashing: A piece of flashing material covering each course of tile at sidewalls.

Stringer: See nailer board.

Sweat Sheet/Bleeder Sheet: A layer of underlayment under the valley metal to prevent moisture/condensation from entering the roof deck.

Tile Course: The horizontal increment of exposure.

Tile Thickness: Any vertical measurement of the cross section of the tiles excluding the lapping area, head or nose lugs, and weather checks.

Tile Thickness (visual): The overall thickness of the tile profile when installed as measured from the top surface of the lower tile to the top surface of the upper tile.

Tile Batten: See Batten

Underlayment: A water shedding membrane installed over the roof sheathing, rafters, or trusses. The underlayment may be rigid or roll form.

Valley: The angle of a roof where two slopes intersect internally.

Closed Valley: Where tile(s) are cut to meet at the center of the valley metal.

Open Valley: Where tile(s) are cut to expose the trough area of the metal.

Vent Tile: A tile designed to allow air circulation from the roof space to the outside.

Water Course: The valley portions of profiled tiles along which water drains.

Weather Blocking: A barrier of moldable or preformed rigid material which blocks the entry of wind driven moisture at openings between the field tile and trim tile or the field tile and roof flashing.

Weather Checks: Protrusion(s) on the tile that are designed to restrict the flow of water between two consecutive courses of tile.

Width: The maximum overall dimension of the tiles as measured perpendicular to the length of the water channel.

Width, Exposed: The maximum overall dimension of the tile as measured perpendicular to the length of the water channel minus the side lap of the adjacent roof tile.

Wire Tie System: A roof tile fastening system approved by the local building code, that limits the penetration of the underlayment and allows tile to be fastened to non-nailable roof decks.

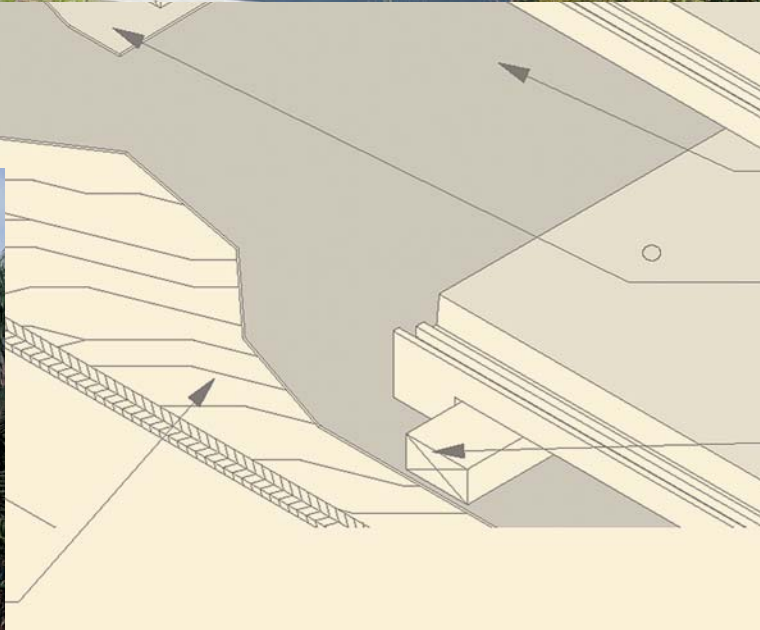
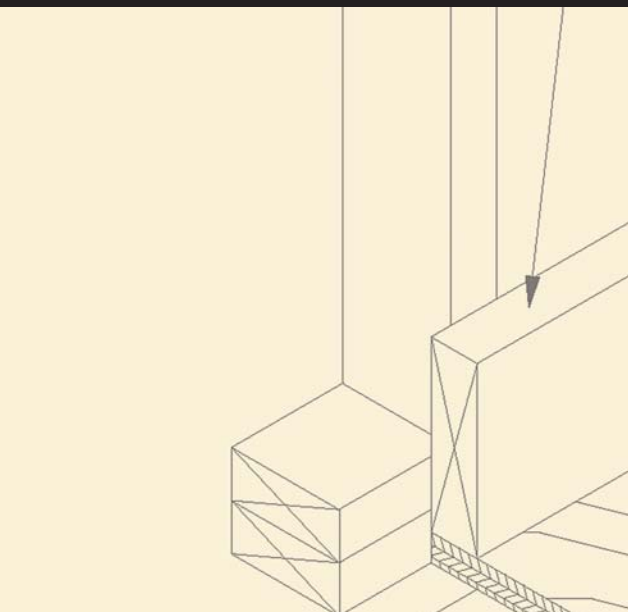

TILE ROOFING INSTITUTE

P.O. Box 40337
Eugene, OR 97404-0049
www.tilerooting.org
Email: info@tilerooting.org



WESTERN STATES ROOFING CONTRACTORS ASSOCIATION

275 Tennant Avenue, Suite #106
Morgan Hill, CA 95037
www.wsrca.com
Email: info@wsrca.com