

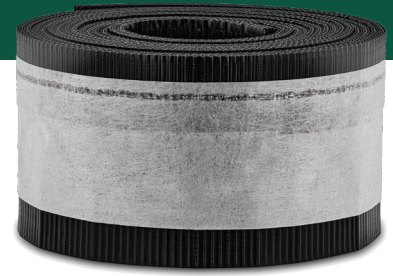

Quarrix®

OffRidge

INTAKE & EXHAUST VENT



EAVE INTAKE OR OFF-PEAK EXHAUST

STEP 1

Slot Preparation

Determine amount of ventilation required and length of slot. Cut a horizontal 3/4" slot in the deck, leaving a minimum of 6" uncut on each end of the slot. Install underlayment and shingles per manufacturer's instructions. Do not cover pre-cut slot.

STEP 2

End Cap Installation

Cut a slit in the StormStop membrane 1/2" by the thick part of vent. Place sealant on both sides of membrane. Insert foam end cap with the thickest side positioned near the air intake and tapered side up the deck where the vent is nailed to the roof deck. Membrane should be touching the plastic part of vent and end cap should be touching roof. An end cap must be placed at the beginning and end of each section.

STEP 3

OffRidge Intake & Exhaust Vent Installation

Lay a bead of sealant 3" below the cut slot. Place front edge of vent 4" below the pre-cut slot. Unfold the membrane and pull straight. Place a bead of sealant 4-1/2" above slot underneath membrane. Nail membrane and plastic to roof deck. All nails must penetrate the roof deck at least 3/4". Nail down the bottom lead edge of vent and in the middle through the end cap. Roll out vent and pull tight; nail at 10' and again at the end of the roll.

STEP 4

Finishing Shingle Installation

Install ice & water barrier and shingles on top of vent, treating the thick edge of the vent as a starter course. Install shingles per manufacturer's instructions.

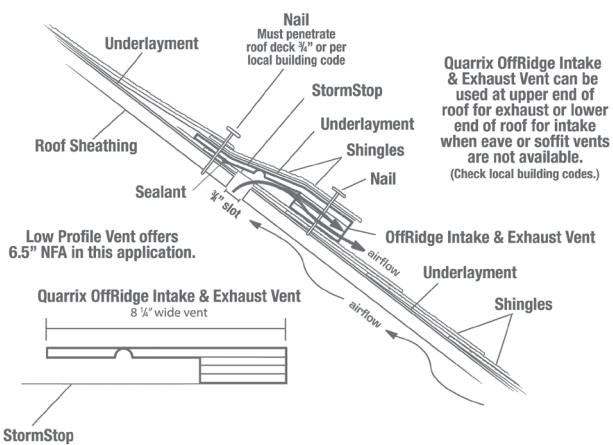
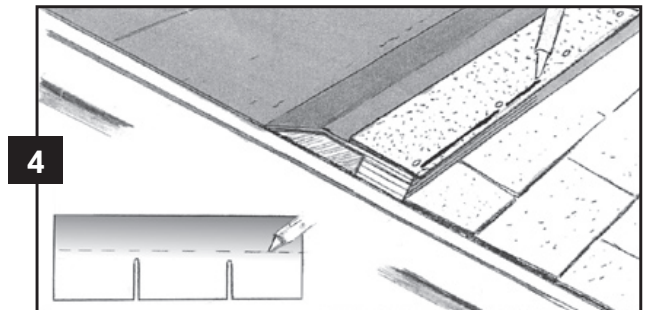
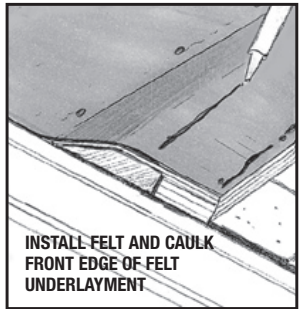
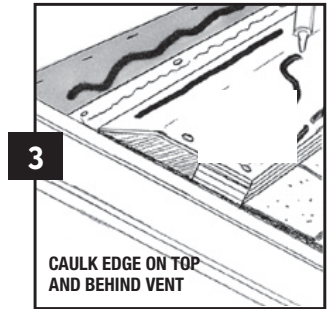
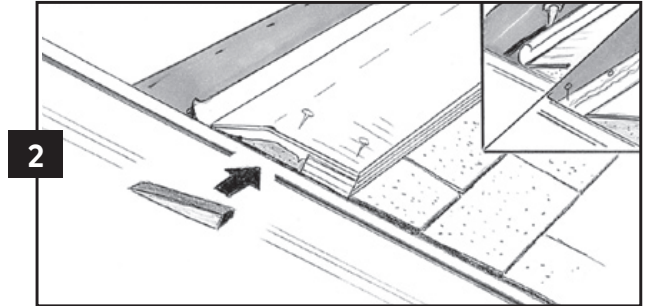
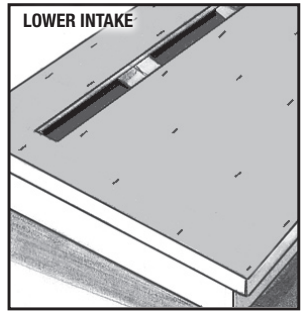
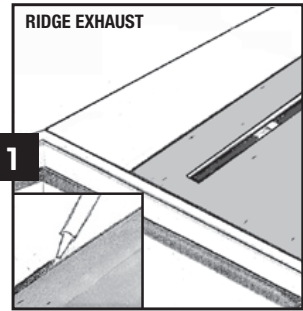
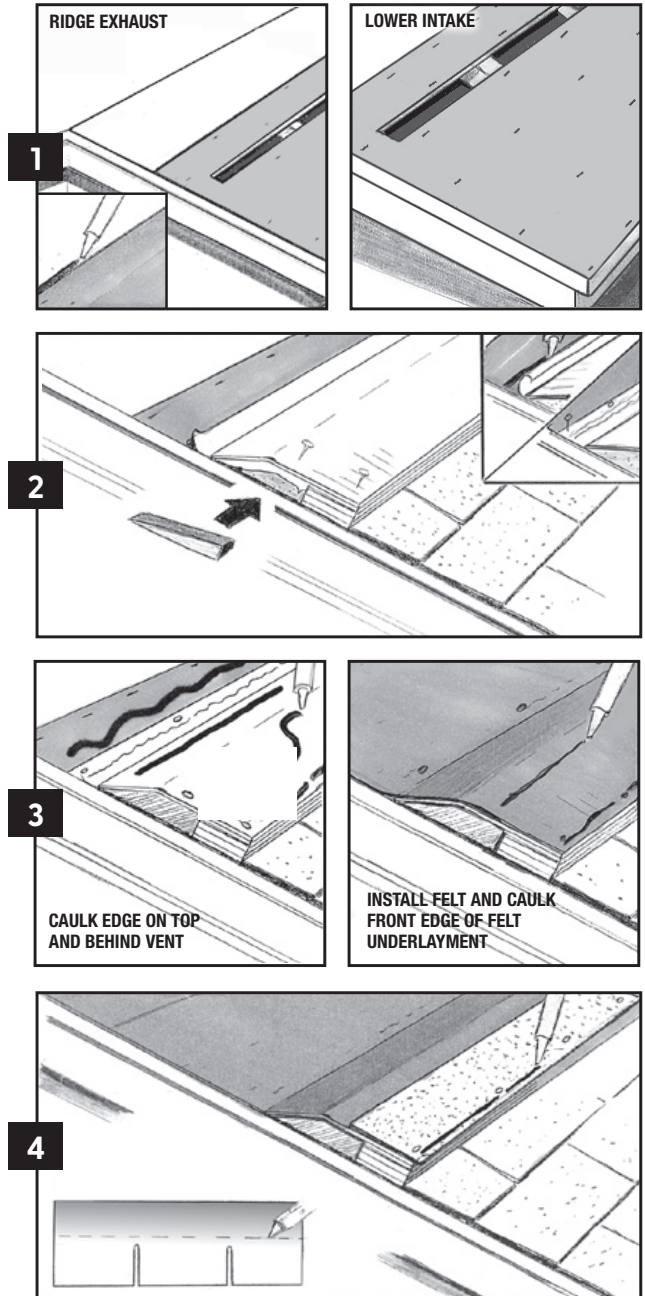

Instructions for use on a tile roof available online at Quarrix.com





Quarrix®

OffRidge

INTAKE & EXHAUST VENT

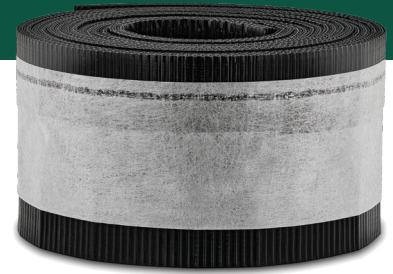

SHED ROOFS (ROOF-TO-WALL)

STEP 1

Slot Preparation

Determine amount of ventilation required and length of slot. Cut a horizontal 1" slot in the deck right before the wall. Leave 6" uncut on each end of the slot. Install underlayment and shingles per manufacturer's instructions.

STEP 2

End Cap Installation

Trim end cap to fit at each end of vent. Cut a slit in the StormStop membrane 1/2" by the thick part of vent. Place sealant on both sides of StormStop membrane. Insert foam end cap with the cut-back StormStop material between the end cap and the underside of the vent. End caps must be installed at the beginning and end of each vent section.

STEP 3

Sealant Placement

Lay a bead of sealant 3" below the cut slot. Place front edge of vent 4" below the pre-cut slot. Unfold the membrane and pull straight. Nail membrane and plastic to roof deck. All nails must penetrate the roof deck at least 3/4". Nail down the bottom lead edge of vent and in the middle through the end cap. Roll out vent and pull tight; nail at 10' and again at the end of the roll.

STEP 4

OffRidge Intake & Exhaust Vent Installation

Nail lead edge of vent into roof deck. Nail foam end cap in place. All nails must penetrate the roof deck at least 3/4". Roll out OffRidge Intake & Exhaust vent and pull tight, nail at 10' and again at the end of the roll. Tack the vent along the wall, making sure nails penetrate plastic and StormStop membrane. Nail every 6".

STEP 5

Finishing

Install metal flashing as counter flashing on top of vent. Install siding over the vent piece on wall. When finished, siding should cover the wall and overlap the metal flashing.

Wildland Urban Interface Compliant

Vents for roof ventilation are often found in the soffit. Placing vents in these locations creates a perfect path for fire to enter the roof structure. If the vent must be in this location it is better to place it farther from the wall and closer to the fascia. The vent can also be placed in the fascia or near the lower edge of the roof.

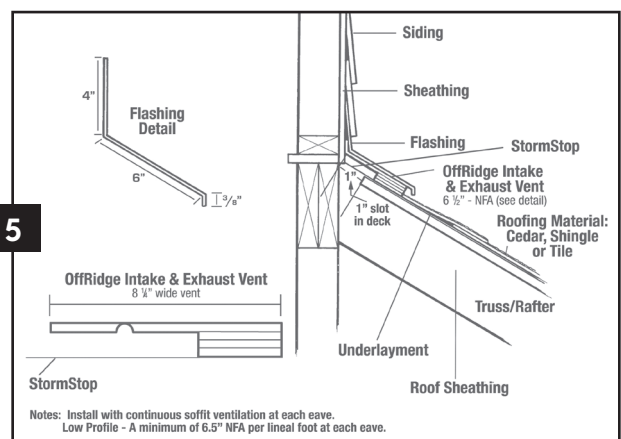
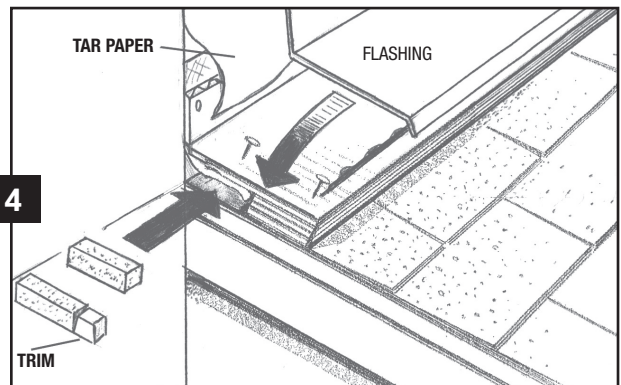
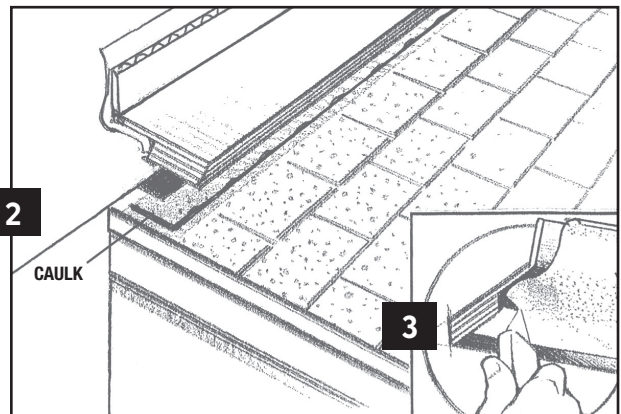
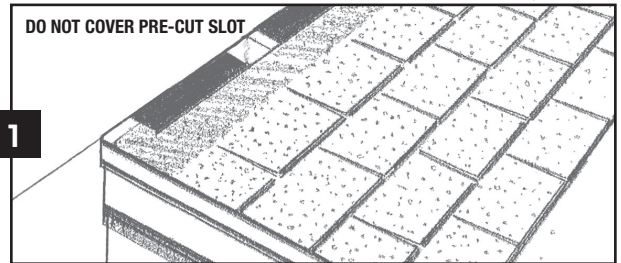
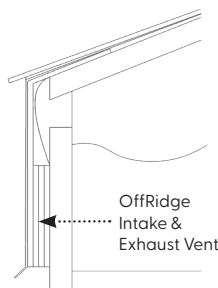

Notes: Install with continuous soffit ventilation at each eave.
Low Profile - A minimum of 6.5" NFA per lineal foot at each eave.